

dweLED 德里格2022产品手册



CREATE
SPIRITUAL
DWELLING
WITH LIGHT

用光缔造精神居所

2022

dweLED 东莞家居概念展厅
地址：广东省东莞市清溪镇清风街390号

dweLED 上海家居展厅
地址：上海市浦东新区毕升路299弄14号

dweLED 美国纽约总部
地址：美国纽约州加登城南街615号



WAC集团旗下高端的家居照明品牌

LIGHT CREATES LIFE AND CONTINUES LIFE.

光生万物

有光的地方，就有了生命，希望与虔诚。

LIGHTING
光的思考
CONCEPTS

一睁开眼睛，我们便能接收光带给我们的世界

光带来光明，也能勾勒阴影

在现在的生活中，光不仅仅是为了照明

更是表达空间形态

营造环境的氛围基本元素

好的照明是

合理的

舒适的

节能环保的

灯光艺术



INDEXES 索引

Create Spiritual Dwelling With Light

BRAND INTRODUCTION
品牌介绍
001-026

dweLED PRODUCTS
德里格产品
027-376

INDEXES 索引

Create Spiritual Dwelling With Light

DOWNLIGHT 筒灯

027-056P



辰星



LA LÍNEA琳奈

TRACK SYSTEM 轨道系统

057-082P

HIGH-PRESSURE RAIL SYSTEM
高压轨道系统 059-062P



CECIO

LOW-VOLTAGE RAIL SYSTEM
低压轨道系统 063-082P



LUCIO



CECIO



LA LÍNEA琳奈



CELINE艺术吊灯



CELINE

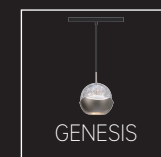

GENESIS

LINEAR SYSTEM 线性系统

083-096P

LED TAPE LIGHT
LED柔性灯带 085-092P

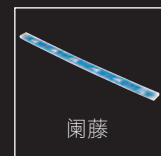

阑藤

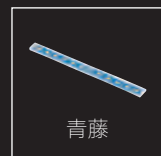

青藤

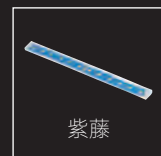

紫藤

LINEAR SURFACE MOUNTED LIGHT
线性明装灯具 093-096P



LA LÍNEA琳奈

CEILING MOUNT LIGHT 吸顶灯

97-102P



CELINE



VAUGHAN

PENDENT LIGHT 吊灯

103-150P



BRANWEN

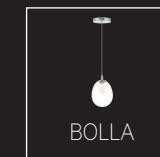

BOLLA



TIC TOC



CHANDRA

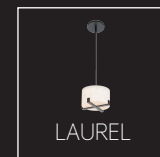

LAUREL



CHRYSALIS

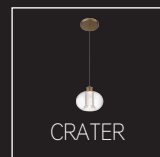

CRATER



ACTION



NAPA



MARQUES



ECHO



TIGHTROPE



EFFERVESCENT



GENESIS



LORA



LA LÍNEA琳奈



CELINE



ELLINGTON



LA LÍNEA PRO

FLOOR LIGHT 落地灯

151-156P

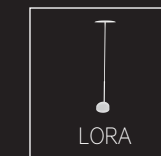

LORA



LA LÍNEA PRO

TABLE LIGHT 台灯

157-162P



STEP LIGHT 踢脚灯

203-208P



WALL LIGHT 壁灯

163-190P

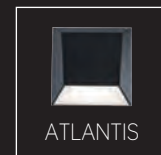
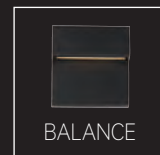
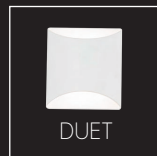

LANDSCAPE 户外景观灯

209-316P



MIRROR HEAD LIGHT 镜前灯

191-196P



PHOTO LIGHT 照画灯

197-202P



ICON REFERENCE

图标注释



绝缘 I 类产品



绝缘 II 类产品



绝缘 III 类产品



环境温度
-20°C -50°C



环境温度
-20°C-40°C



环境温度
5°C-40°C



可调光灯具



220V 可调光灯具



兼容 DMX512 协议



兼容 DALI 协议



输入电压
220V AC/50Hz



输入电压
220V-240V AC 50Hz



输入电压
100V-240V AC 50Hz



输入电压
24V ON-OFF



输入电压
12V AC 50/60Hz



输入电压
220V AC 50/60Hz



低压输入
24V DC



低压输入
48V DC



CCC 类型认证产品



CQC 类型认证产品



高显色指数产品
(Ra>90)



支持无线连接



保护等级



保护等级



保护等级



保护等级



保护等级



保护等级



专利 SUBROSA® 隐光技术

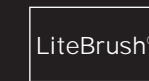

专利 光瀑® 洗墙系统

WAC LIGHTING
G L O B A L
华格照明全球区域布局
R E G I O N A L
L A Y O U T

WAC 集团

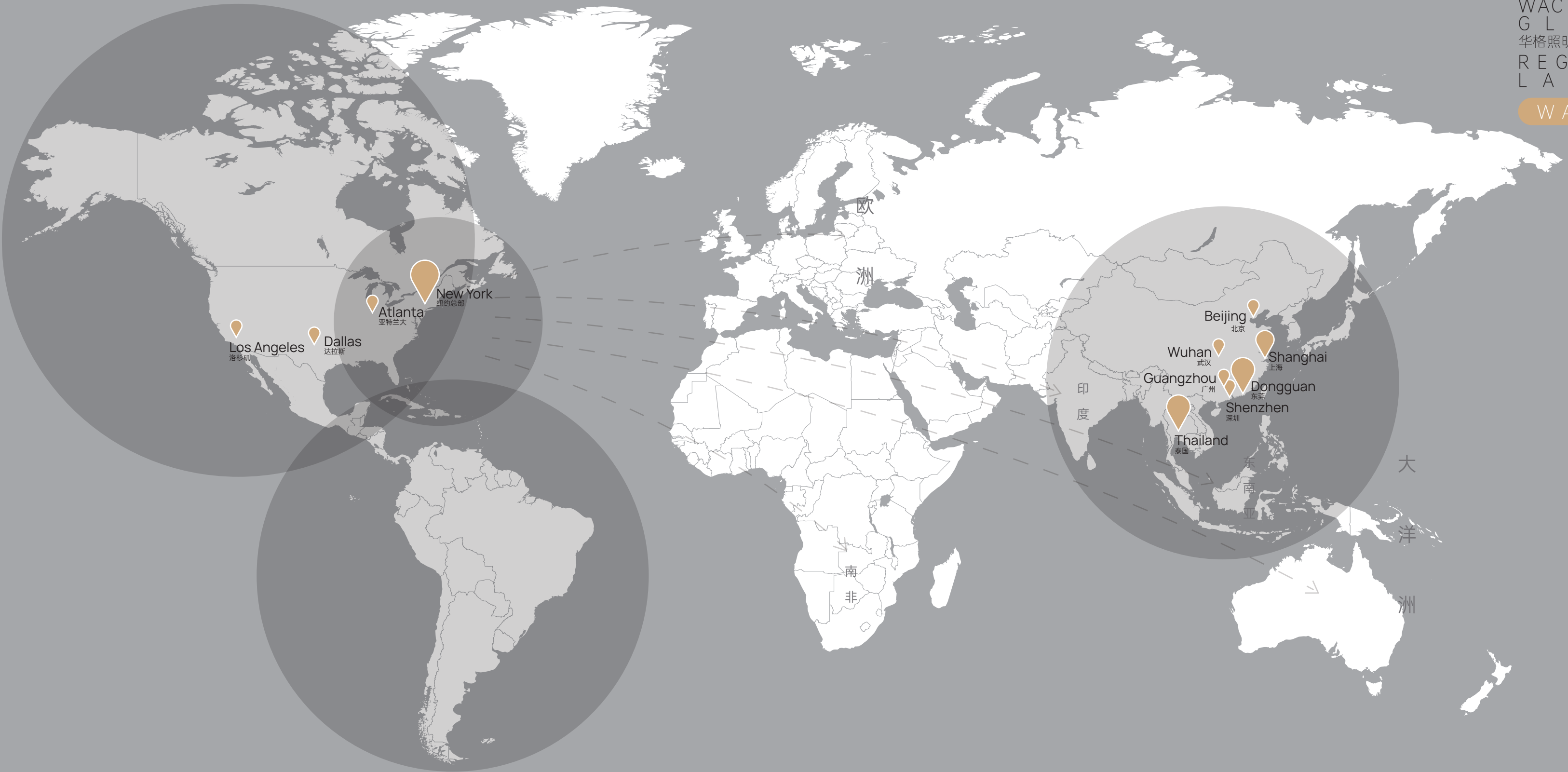



以责任，耀文明

RESPONSIBLE LIGHTING ENHANCES OUR CULTURE AND CIVILIZATION

华格全球 WAC GLOBAL

WAC 1984年诞生于纽约，是具有全球视野的专业级照明品牌。

以“责任照明”作为品牌标准，倡导环保制造和节能技术。

WAC一直致力于提升行业设计与生产水平，坚持自主产品的研发与制造，在电子开发、研究、测试实验室以及生产设备的投入不断扩大，如今已然成长为独一无二的世界级照明品牌。

华格中国 WAC CHINA

WAC亚太区总部，成立于2010年，位于国际化大都市——上海，取名“华格”，寓意放眼世界，立足中国，以国际化视野与水准，打造中国的高品质专业照明。

技术创新是WAC华格的品牌核心，多年来我们一直致力于国际前沿技术的研究与创新，研发出的SUBROSA隐光、LiteBrush光瀑、LiteBox偏光洗墙等核心技术，广泛运用到博物馆照明产品中，相继完成了故宫博物院、南京牛首山、良渚博物院、曲阜尼山等重要文化圣地，用丰富的灯光灵感，焕发文物璀璨新生。

WAC 中国



服务逾40%+国家一级博物馆
展陈展示空间

故宫博物院慈宁宫
中国人民革命军事博物馆
良渚博物馆
郑州博物馆
上海天文馆
.....



牵手20+知名地产集团，建立长期合作
商业地产空间

恒隆广场
万象城
杭州国际博览中心
厦门国际会议中心
北京环球影城
.....



为200+国际高端酒店提供照明解决方案
酒店照明

深圳丽兹卡尔顿
上海JW万豪侯爵酒店
上海外滩W酒店
杭州柏悦酒店
上海中心J酒店
.....



为国内诸多大型、地标性项目提供全方位解决方案
户外照明

南通大剧院
苏州奥林匹克体育中心
贵阳摩根
南京中国科举博物馆
北京首创丽泽
.....



多次参与国家级战略合作会议
大型会展空间

北京APEC
杭州G20
厦门金砖
乌镇互联网大会
.....



为1000+高端别墅、精品公寓等提供照明解决方案
高端住宅

上海汤臣别墅
万科红树湾公寓
北京四季世家别墅
深圳天麓别墅
上海东紫园别墅
.....

BRAND HISTORY
IN RECENT 40
近40年品牌历程
YEARS

1984-2022

WAC集团

1984
Founded in New York
成立于纽约

1997
Completed global
manufacturing base(Chinese mainland)
全球制造基地 (中国大陆)

2010
Set up Asia Pacific headquarters
亚太区总部
华格照明科技 (上海) 有限公司
同时增设北京分公司、广州、武汉、
成都、深圳等办事处

2019
Debuted in the Chinese market
家居照明品牌德里格
正式引入中国市场
Set up Shenzhen
IOT Technology Research Center
设立深圳IOT技术研究中心

1993
Set up showroom in
Dallas market center
设立达拉斯永久展厅

1998
Set up California
branch
设立加利福尼亚分公司

2014
Set up ATLANTA
branch
设立亚特兰大分公司

2021
Acquired schonbek, a 150-year-old
luxury crystal brand from Swarovski
收购施华洛世奇旗下具有150年
历史的豪华水晶照明品牌schonbek
Set up Thailand factory
(Thai Ming Lighting Co., Ltd)
设立泰国工厂 (泰明)

G L O B A L
全球生产基地
PRODUCTION BASE

ISO-9001 ISO-14001
双体系认证
现代精益化管理生产基地

建筑面积70000m²
全球近2000名员工

全球顶尖加工制造设备
全球7大实验室认证

TYPE C SPOT
全空间分布式光度测量系统
GONIOPHOTOMETER

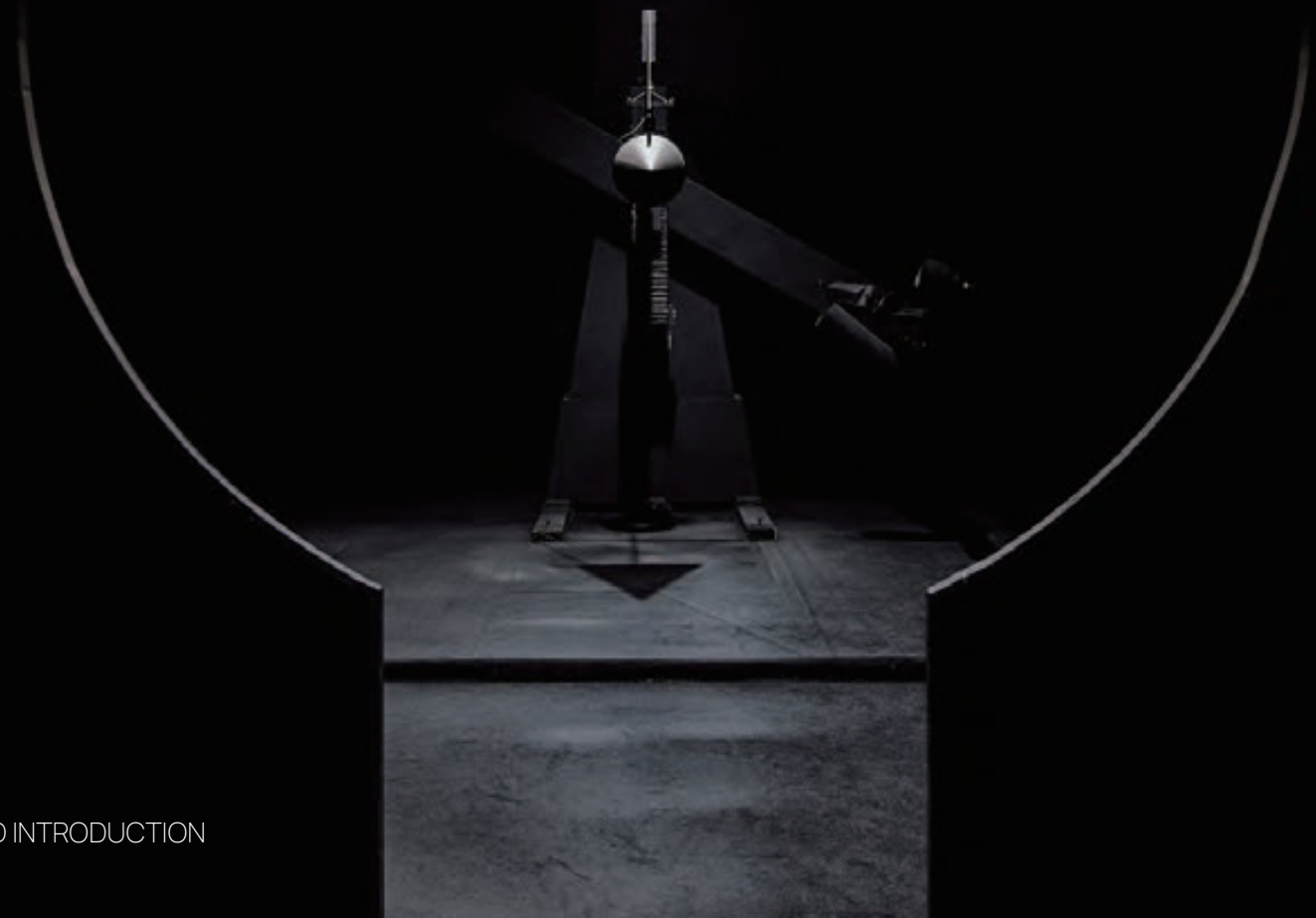

INTERNATIONALLY
RECOGNIZED
国际认可的实验室
TESTING LAB



中国CNAS
实验室认可



美国UL
授权实验室认可



美国能源之星
实验室认可



ETL授权实验室认可



美国国家NVLAP
实验室认可



CTC授权实验室认可



美国加州title24实验室认可



ANECHOIC
特殊声学实验室
CHAMBER

INNOVATION
创 新 力



300+专利

20+发明

119+外观设计

169+实用新型



AWARDS &
奖项与荣誉
ACCOLADES

2015 2015
中照奖一等奖
美国IES优秀奖
FIRST PRIZE ZHONGZHAO AWARD
AMERICAN IES EXCELLENCE AWARD

2020 2020
IALD优秀奖
IALD EXCELLENCE AWARD

2021年 2021
亚洲照明设计大奖
光艺术类特别之光奖
ASIAN LIGHTING DESIGN AWARDS
SPECIAL LIGHT AWARD FOR LIGHT ART

2015 2015
LIGHTING EXHIBITION
(LFI) INNOVATIVE PRODUCT OF THE YEAR AWARD
照明展览会
(LFI)年度创新产品奖

2016 2016
WA SCIENCE AND TECHNOLOGY PROGRESS AWARD
WA科技进步奖

2020 2020
IES LIGHTING EXCELLENCE AWARDS
IES照明卓越大奖

2021 2021
SECOND PRIZE ZHONGZHAO AWARD
中照奖二等奖

USING LIGHT
用光，在博物馆传承文化
TO PRESERVE CULTURE
IN MUSEUMS

故宫博物院

TO EXTOL ART
用光，在美术馆颂扬艺术
IN MUSEUMS

木心美术馆

USING LIGHT
TO DELICATE
用光，在五星级酒店精雕空间
DECORATE SPACE
IN FIVE-STAR HOTELS

上海中心J酒店



DEMONSTRATE
THE SPIRIT OF CHINA
用光，耀华夏精神
WITH LIGHT

杭州国际博览中心

dweLED德里格 国际专业的照明品牌

2019年引入到中国市场 是WAC集团旗下高端的家居照明品牌
主要应用于别墅 大平层 精装住宅 高端公寓 私人会所等精品家居场所
用精湛的工艺 杰出的光学技术 通过光满足人类的精神追求

德里格

卓越的光效来源于WAC Lighting
近40年在商照领域的实践

dweLED

THE PERFECT LIGHT EFFECT COMES FROM WAC LIGHTING
NEARLY 40 YEARS OF PRACTICE IN THE FIELD OF BUSINESS LIGHTING.

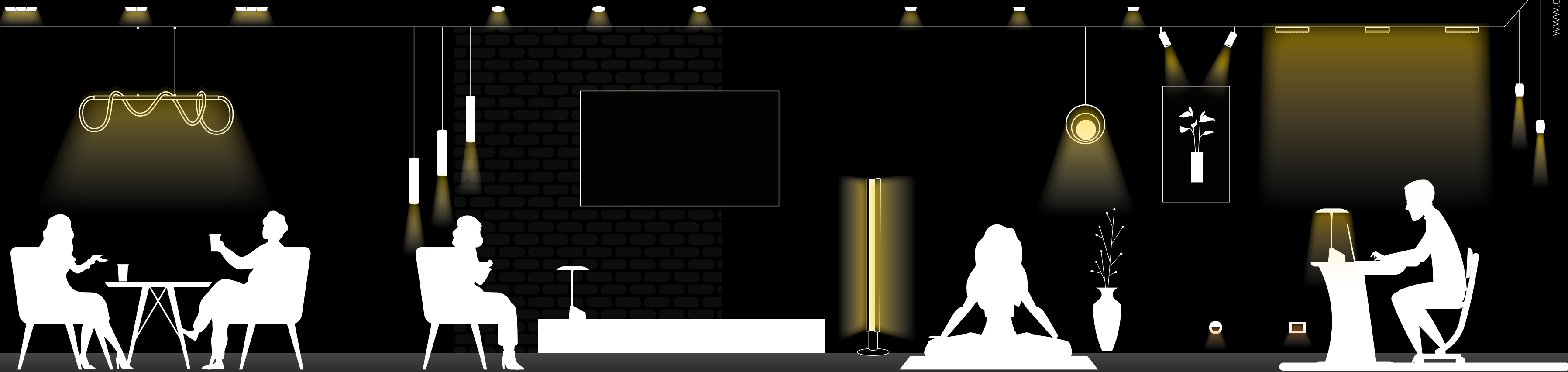

dweLED 人文之光，研究人与空间的关系，研究光对人的情感的影响

光本身就是一种语言

dweLED用光线给人带来自然与舒适 安宁与平静 欣赏与享受 专注与自信

通过气氛的营造 情绪的调动，环境的烘托，满足人类精神层面深层次的需求

让人们感受生命内在的丰厚与完美

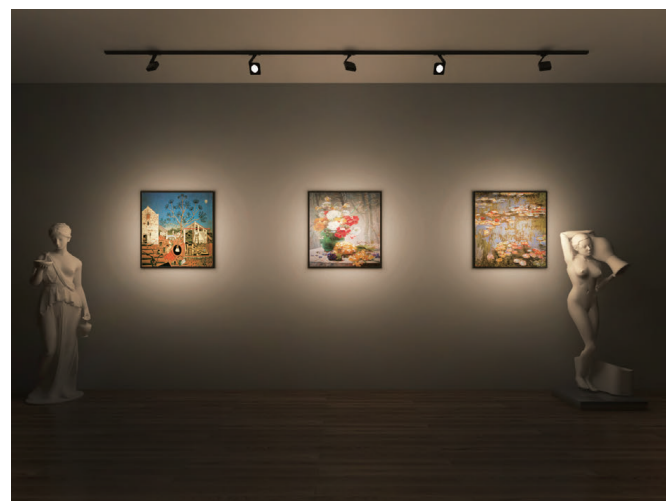

R I C H
P R O D U C T
丰 富 的 产 品 线
L I N E

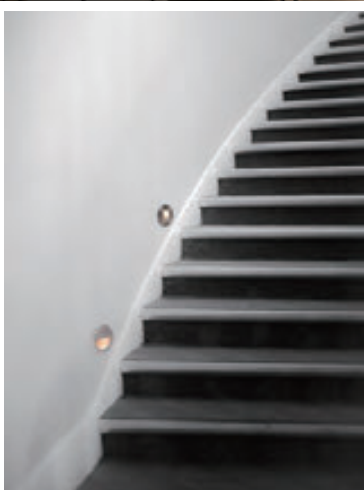
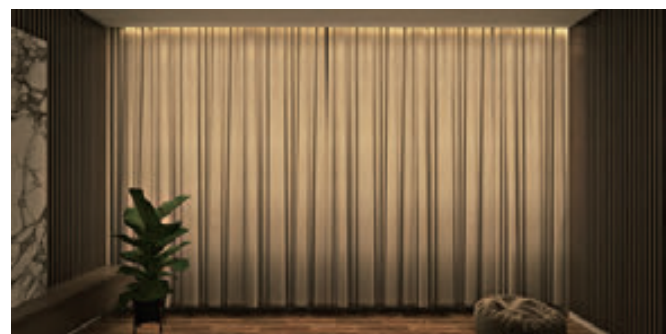
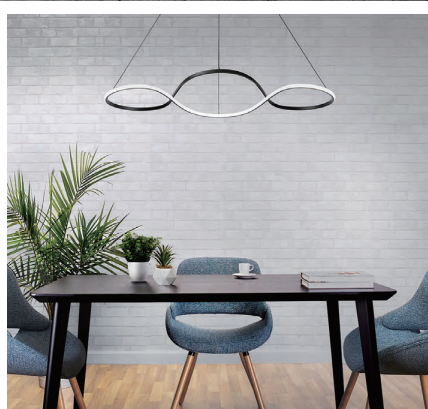

CHENXING, THE ANCIENT NAME FOR MERCURY,
ACCORDING TO THE TALE, THE LAST BEAM OF LIGHT BEFORE THE DAWN CAN
ONLY BE OBSERVED BETWEEN THE DAWN AND DUSK,
WHICH LOOKS LIKE THE ORIGIN OF COSMOS AT THE END OF DARK NIGHT, SUBLIMING ALL RESIDENCES.
FOR YOU, WE CONSTRUCT AN ILLUMINATION ENVIRONMENT ABOUNDING WITH PHILOSOPHIES.

辰星，水星的古称
传说仅在晨昏之际可见，暗夜尽头
黎明破晓前的最后一束光
似宇宙中之本源升华居所
为你打造富有哲学的光环境

辰星

029-050P

CHENXING SERIES OF DOWNLIGHTS

辰星系列产品优势

模拟自然光

全光谱，高显指，贴合自然光
满足人体节律需求



丰富的配件

满足多空间，多场景，不同功能的需求



杰出的光学技术

LiteBrush®光瀑洗墙技术
专利号：201721002833.7 专利类型：实用新型

SUBROSA®专利隐光技术
专利号：ZL201721133103.0 专利类型：实用新型

强大的参数

可变色温 / 多种角度 / 尺寸丰富

反射器颜色丰富
满足您的多种需求



分体式安装设计

"不破坏"石膏天花板，利于维护，更换简单。

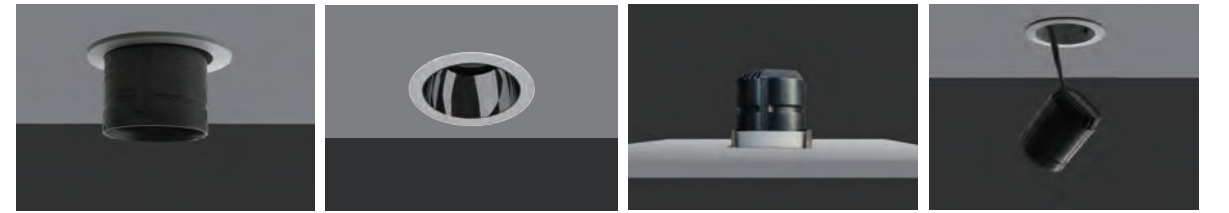

传统反射器

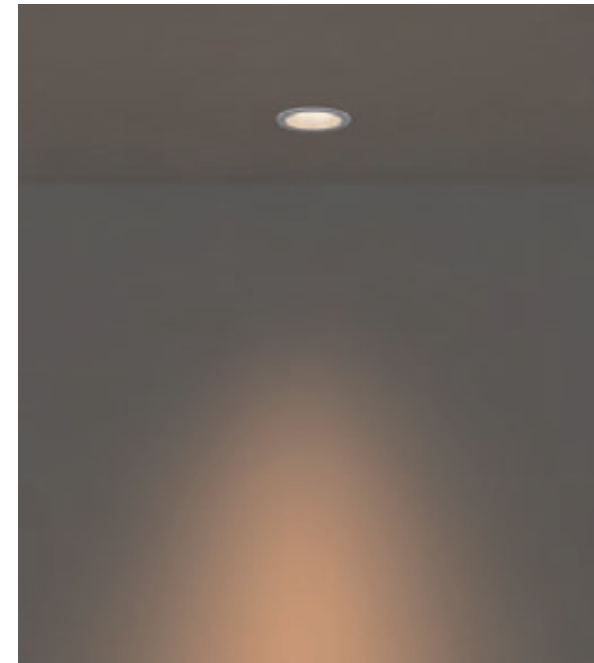

SUBROSA®专利隐光技术

专利号: ZL201721133103.0 专利类型: 实用新型

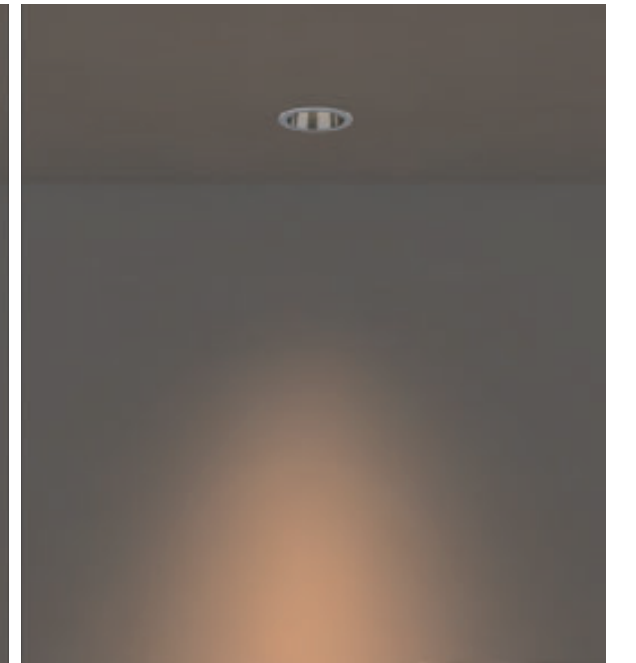

照射角度

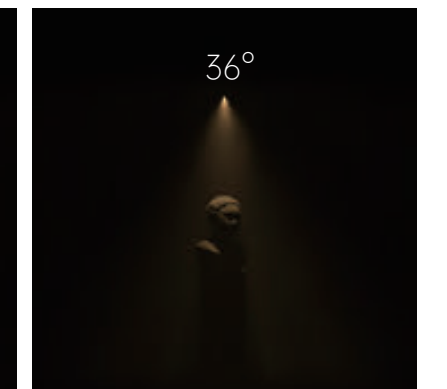
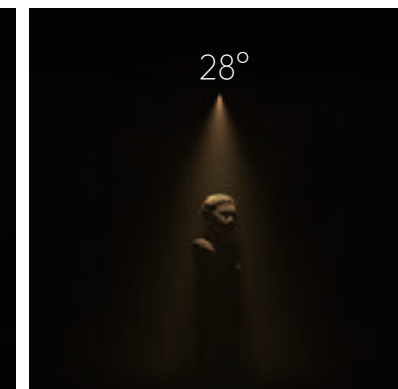
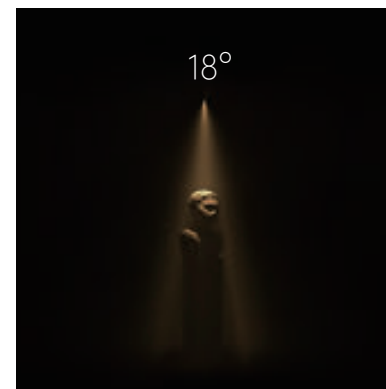

dweLED



用 光 缔 造 精 神 居 所

辰星配件

订购模型请详见360-361页



辰星反射器



安装方式



3种开孔尺寸

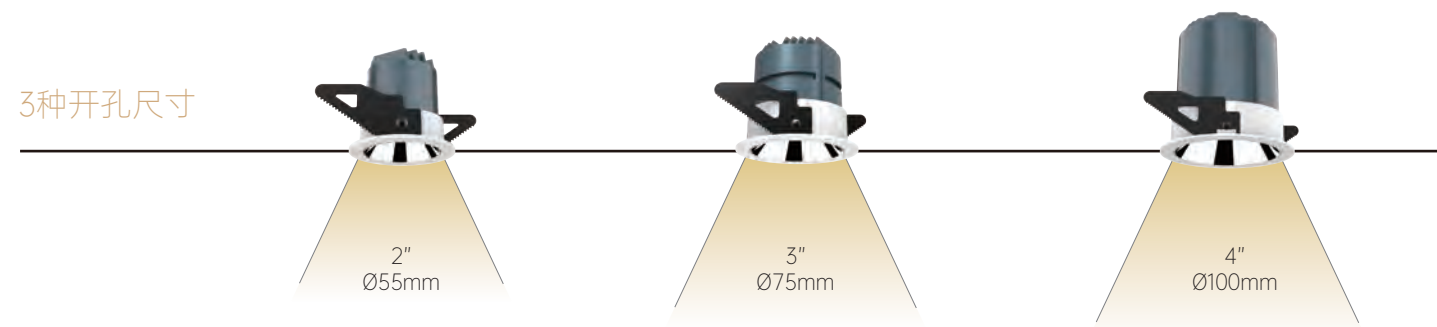

功能

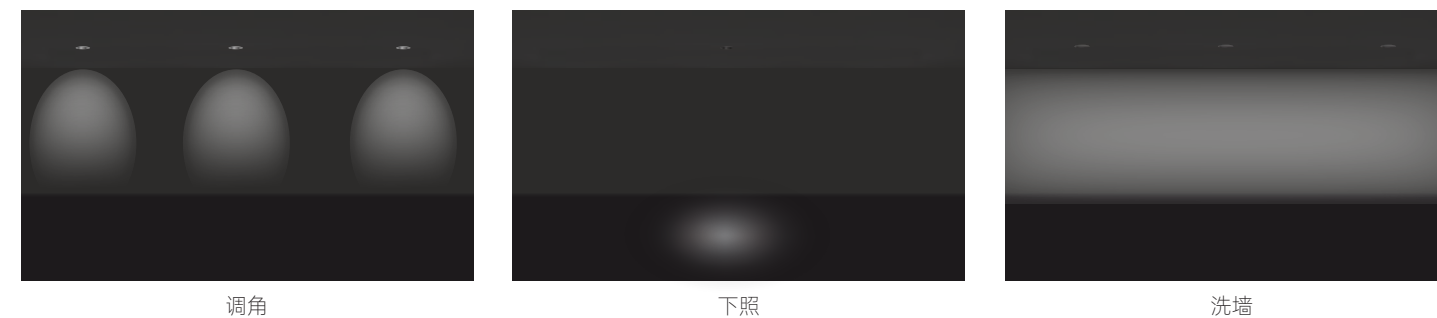



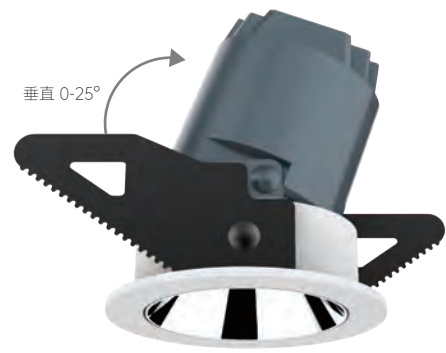

辰星 2" 圆形

主体材质 铝合金压铸灯身
 颜色 ●
 光源类型 COB
 光源功率 5W/7W
 光源光通量 660lm@7W, 3000K
 色温/显指 2700K/3000K/3500K/4000K, Ra90
 2700K-6500K 可变色温, Ra > 90
 光源色容差 3 SDCM
 光源寿命 >36,000h-L70 /B10-Ta25°C(LM-80/TM-21)
 光学系统 透镜+反射器
 光束角 18°/28°/36°
 遮光角 30°
 调光控制 ON-OFF、0-10V调光 (需与现场做匹配性测试)
 投射方向 垂直 0-25°
 开孔尺寸 Ø55mm
 天花厚度 9mm-15mm



订购模型请详见317页

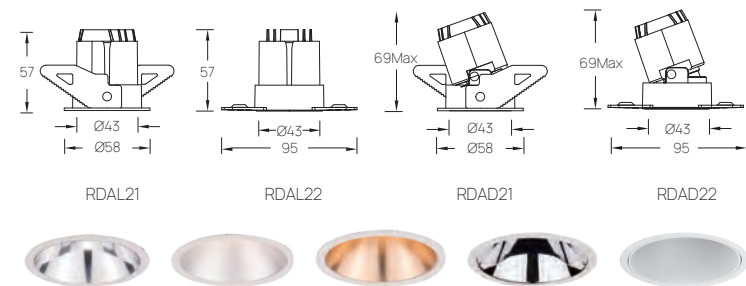

辰星 2" 方形

主体材质 铝合金压铸灯身
 颜色 ●
 光源类型 COB
 光源功率 5W/7W
 光源光通量 660lm@7W 3000K
 色温/显指 2700K/3000K/3500K/4000K, Ra90
 2700K-6500K 可变色温, Ra > 90
 光源色容差 3 SDCM
 光源寿命 >36,000h-L70 /B10-Ta25°C(LM-80/TM-21)
 光学系统 透镜+反射器
 光束角 18°/28°/36°
 遮光角 30°
 调光控制 ON-OFF、0-10V调光 (需与现场做匹配性测试)
 投射方向 垂直 0-25°
 开孔尺寸 □55mm
 天花厚度 9mm-15mm



订购模型请详见317页

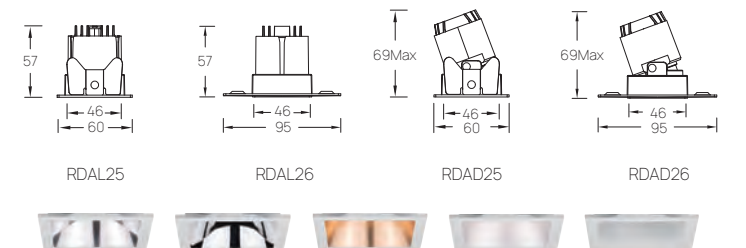



辰星 3" 圆形

主体材质 铝合金压铸灯身
 颜色 ●
 光源类型 COB
 光源功率 7W/10W
 光源光通量 1150lm@10W 3000K
 色温/显指 2700K/3000K/3500K/4000K, Ra90
 2700K-6500K 可变色温 (全光谱), Ra > 95
 光源色容差 3 SDCM
 光源寿命 >36,000h-L70 /B10-Ta25°C(LM-80/TM-21)
 光学系统 透镜+反射器
 光束角 18°/28°/36°
 遮光角 30°
 调光控制 ON-OFF、0-10V调光 (需与现场做匹配性测试)
 投射方向 垂直 0-25°
 开孔尺寸 Ø75mm
 天花厚度 9mm-25mm



订购模型请详见318页

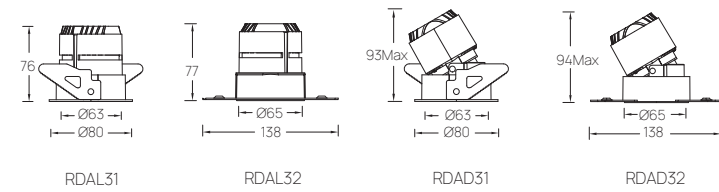

辰星 3" 方形

主体材质 铝合金压铸灯身
 颜色 ●
 光源类型 COB
 光源功率 7W/10W
 光源光通量 1150lm@10W 3000K
 色温/显指 2700K/3000K/3500K/4000K, Ra90
 2700K-6500K 可变色温 (全光谱), Ra > 95
 光源色容差 3 SDCM
 光源寿命 >36,000h-L70 /B10-Ta25°C(LM-80/TM-21)
 光学系统 透镜+反射器
 光束角 18°/28°/36°
 遮光角 30°
 调光控制 ON-OFF、0-10V调光 (需与现场做匹配性测试)
 投射方向 垂直 0-25°
 开孔尺寸 □75mm
 天花厚度 9mm-25mm



订购模型请详见318页

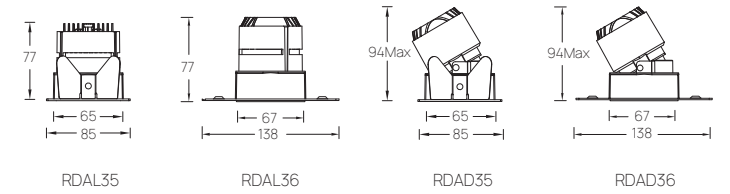



辰星 4" 圆形

主体材质 铝合金压铸灯身
 颜色 ●
 光源类型 COB
 光源功率 18W/22W
 光源光通量 2500lm@22W 3000K
 色温/显指 2700K/3000K/3500K/4000K, Ra90
 2700K-6500K 可变色温 (全光谱), Ra > 95
 光源色容差 3 SDCM
 光源寿命 >36,000h-L70 /B10-Ta25°C(LM-80/TM-21)
 光学系统 透镜+反射器
 光束角 18°/28°/36°
 遮光角 30°
 调光控制 ON-OFF、0-10V调光 (需与现场做匹配性测试)
 投射方向 垂直 0-25°
 开孔尺寸 Ø100mm
 天花厚度 9mm-25mm



订购模型请详见319页

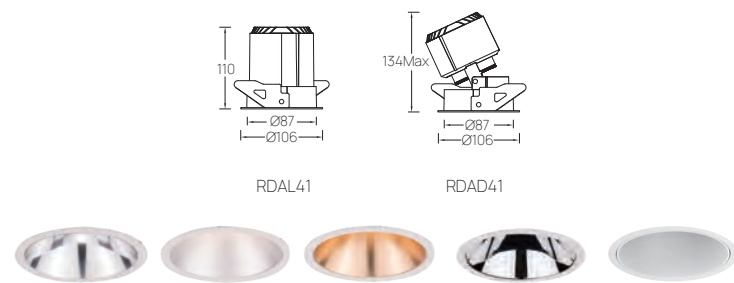

辰星 4" 方形

主体材质 铝合金压铸灯身
 颜色 ●
 光源类型 COB
 光源功率 18W/22W
 光源光通量 2500lm@22W 3000K
 色温/显指 2700K/3000K/3500K/4000K, Ra90
 2700K-6500K 可变色温 (全光谱), Ra > 95
 光源色容差 3 SDCM
 光源寿命 >36,000h-L70 /B10-Ta25°C(LM-80/TM-21)
 光学系统 透镜+反射器
 光束角 18°/28°/36°
 遮光角 30°
 调光控制 ON-OFF、0-10V调光 (需与现场做匹配性测试)
 投射方向 垂直 0-25°
 开孔尺寸 □100mm
 天花厚度 9mm-25mm



订购模型请详见319页

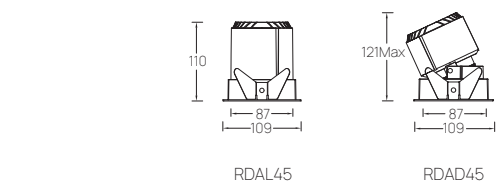
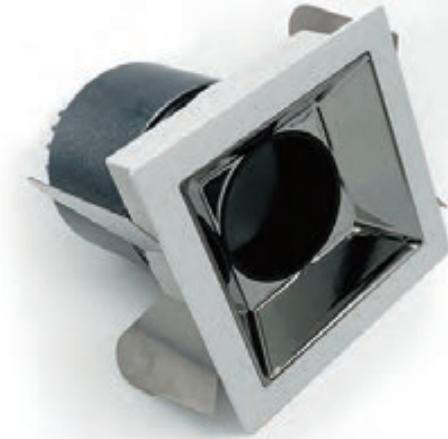





辰星 3" 4" 圆形洗墙

主体材质 铝合金压铸灯身
 颜色 ●
 光源类型 COB
 光源功率 7W(3"); 18W/22W(4")
 光源光通量 3" 800lm; 4" 2200lm@22W 3000K
 色温/显指 2700K/3000K/3500K/4000K, Ra90
 2700K-6500K 可变色温, Ra > 90
 光源色容差 3 SDCM
 光源寿命 >36,000h-L70 /B10-Ta25°C(LM-80/TM-21)
 光学系统 LiteBrush®光学系统
 光束角 Wall Washer
 调光控制 ON-OFF、0-10V调光 (需与现场做匹配性测试)
 开孔尺寸 3" Ø75; 4" Ø100mm
 天花厚度 9mm-25mm



订购模型请详见320页

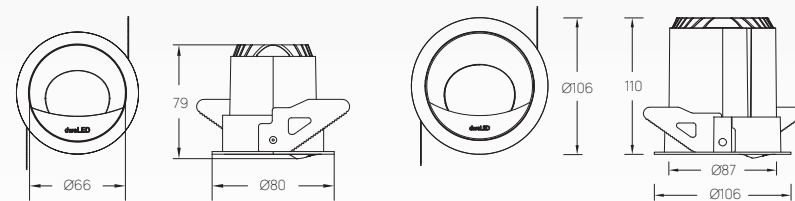

RDAW31

RDAW41

传统洗墙
 截止线明显 光斑严重

LiteBrush®光瀑洗墙技术
 像用水洗过的墙面 柔和干净

专利号: 201721002833.7 专利类型: 实用新型



辰星 3" 多头方形

主体材质 铝合金压铸灯身
 颜色 ●
 光源类型 COB
 光源功率 2×7W, 2×10W / 3×7W, 3×10W
 色温/显指 2700K/3000K/3500K/4000K, Ra90
 2700K-6500K 可变色温 (全光谱), Ra > 95
 光源色容差 3 SDCM
 光源寿命 >36,000h-L70 /B10-Ta25°C(LM-80/TM-21)
 光学系统 透镜+反射器
 光束角 18°/28°/36°
 遮光角 30°
 调光控制 ON-OFF、0-10V调光 (需与现场做匹配性测试)
 投射方向 垂直 0-25°
 开孔尺寸 2头 □75x149mm; 3头 □75x215mm
 天花厚度 9mm-25mm



订购模型请详见 320页

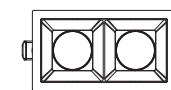
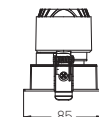
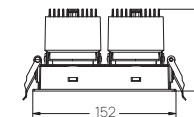

RDAM35

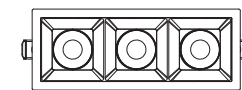
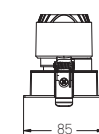
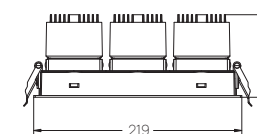

RDAM35



OVERALL SITUATION ORIENTED ARTS,
MINIMALIST DOWN LIGHTS EXHIBIT A STREAMLINE AND NEAT SPACE,
OFFERING HARMONIOUS ILLUMINATION ENVIRONMENT IN A TRANQUIL WAY,
FOILING COZY AND PREMIUM ATMOSPHERE,
WHICH IS THE PERFECT COMBINATION OF AESTHETICS AND ARTS.

大局观的艺术
极致精简嵌入式的灯具 力保极简干净的整体空间
默默的为环境提供着和谐的照明
烘托舒适高端的氛围
是美学与艺术的完美结合



LA LÍNEA琳奈

051-056P



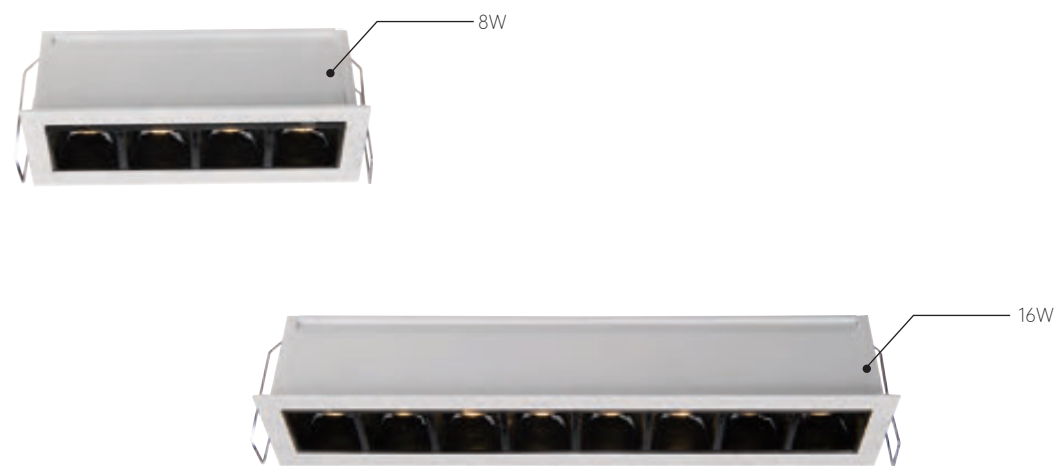

LA LÍNEA琳奈 8W/16W 下照

主体材质 铝合金挤出灯身
 颜色 ● ○
 光源类型 High Power LED
 光源功率 8W/16W
 光源光通量 3000K 1000lm(8W)/3000K 2000lm(16W)
 色温/显指 2700K/3000K/4000K, Ra90
 光源色容差 SDCM
 光源寿命 >50000h-L70 /B10-Ta25°C(LM-80/TM-21)
 光学系统 透镜+SUBROSA®隐光系统
 光束角 15°/28°/36°
 遮光角 35°
 调光控制 ON-OFF、0-10V调光 (必须提前与项目现场系统做匹配测试)
 开孔尺寸 □124mm*38mm(8W)/□236mm*38mm(16W)
 天花厚度 1-25mm



订购模型请详见321页

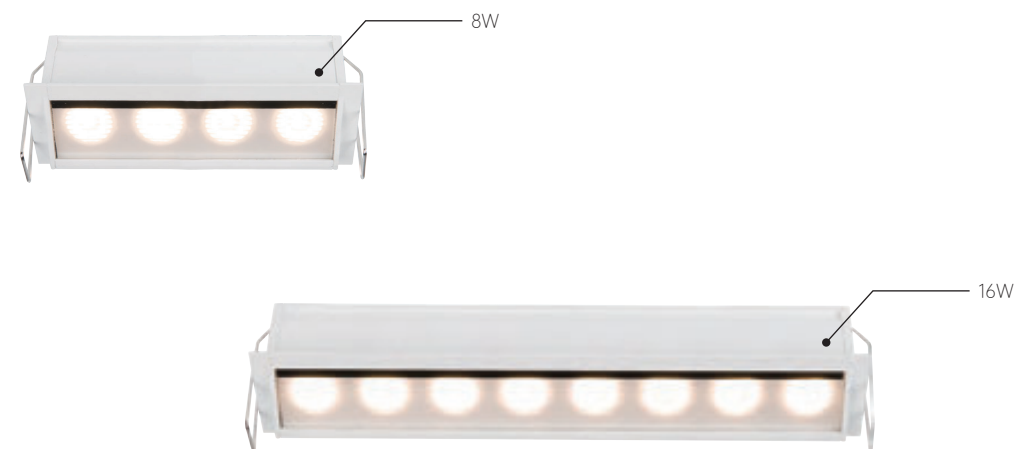
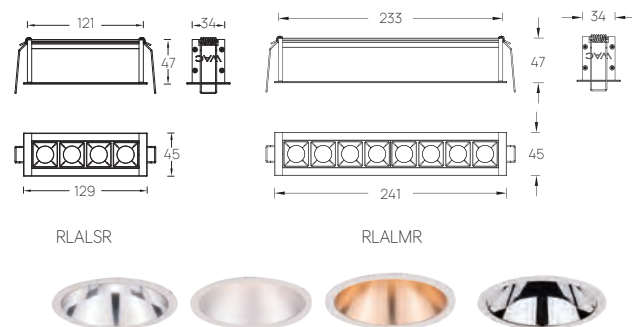

LA LÍNEA琳奈 8W/16W 洗墙

主体材质 铝合金挤出灯身
 颜色 ● ○
 光源类型 High Power LED
 光源功率 8W/16W
 光源光通量 2700K 900lm/3000K 1000lm/4000K 1100lm(8W); 3000K 2000lm(16W)
 色温/显指 2700K/3000K/4000K, Ra90
 光源色容差 SDCM
 光源寿命 >50000h-L70 /B10-Ta25°C(LM-80/TM-21)
 光学系统 透镜
 光束角 Wall Washer
 遮光角 35°
 调光控制 ON-OFF/0-10V调光 (必须提前与项目现场系统做匹配测试)
 开孔尺寸 □124mm*38mm(8W)/□236mm*38mm(16W)
 天花厚度 1-25mm



订购模型请详见321页

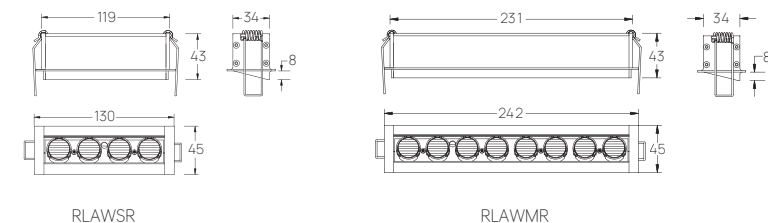

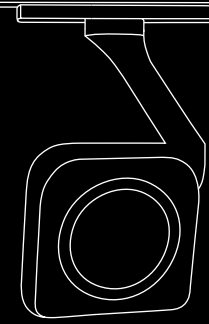
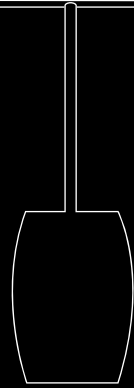
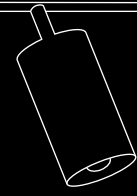

IN THE NATURAL ENVIRONMENT, LOOKING FOR AN ELEGANT PLACE,
dweLED ENDOWS THE RESIDENCE WITH ETERNAL ARTISTIC PURSUIT BY VIRTUE OF LIGHTS.

于自然之境 觅雅致之所
dweLED德里格用灯光赋予居所永恒的艺术追求

TRACK SYSTEM 轨道系统

057-082P

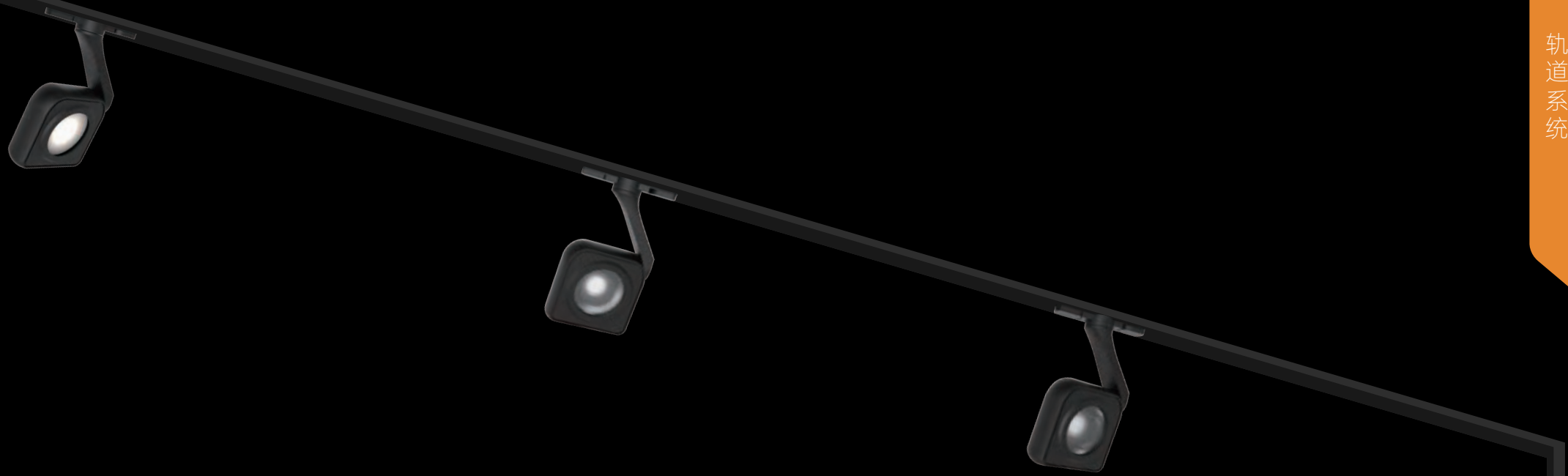

THINNESS AESTHETICS WITH ENTHUSIASM CHARACTERISTICS, GATHERING LIFE BEAUTY,
ACHIEVING PRECISE LIGHT PROJECTION WHILE DISPLAYING OVERALL ARTISTIC SHAPE LOVELINESS.

纤薄美学 个性超燃 聚焦生活之美
在实现精准投射的同时 整体造型富有艺术美感

高压轨道系统

059-062P



CECIO 高压超薄轨道灯

主体材质 铝合金压铸灯体
 颜色 ● ○
 光源类型 COB
 光源功率 12W/18W
 色温/显指 3000K/4000K, Ra90
 光源色容差 5 SDCM
 光源寿命 >36000h-L70 /B10-Ta25°C(LM-80/TM-21)
 光束角 18°/28°/36°
 调光控制 ON-OFF/0-10V Dimming
 投射方向 水平 0°~355°调节, 竖直 0°~90°调节

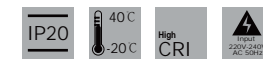

订购模型请详见322页 配件订购模型请详见362-363页

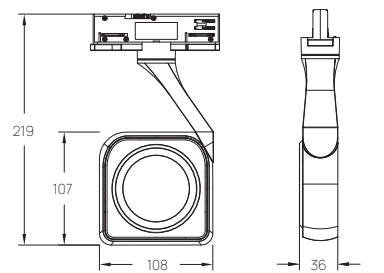

RTBSS

STYLISH BUT OUTSTANDING, BORN FOR ILLUMINATION FUN,
SAFE VOLTAGE FOR HUMAN BODY FREE DIY REPLACEMENT ,
DOUBLE SHOCK RESISTANCE DESIGN MORE SOLID,
ILLUSTRATING CLASSIC BRAND WITH GLOBAL QUALITY .

潮，而不凡 为照明乐趣而生
人体安全电压 自由DIY更换
双重防掉落设计 更牢固
以全球品质演绎品牌经典



低压轨道系统

063-082P

潮而不凡

为照明乐趣而生

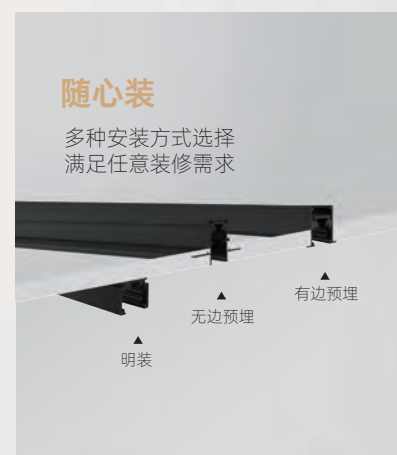



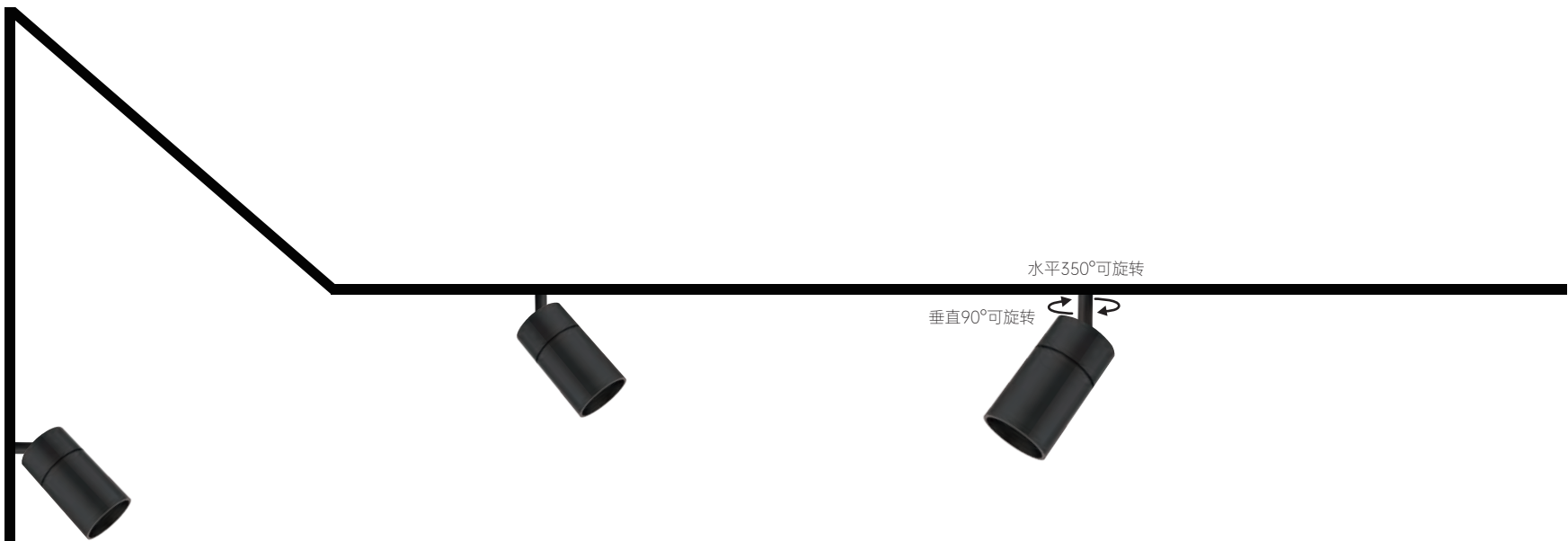

LUCIO轨道射灯 6W/25W

主体材质 优质铝合金材质
 颜色 ● ○
 光源类型 COB
 光源功率 6W/25W
 色温/显指 3000K/4000K, Ra > 90;
 全光谱可变色温 (2700K-6500K), Ra > 95
 光源色容差 5 SDCM/3 SDCM
 光源寿命 >36,000h-L70 / B10-Ta25°C(LM-80/TM-21)
 光学系统 透镜+反射器
 光束角 18°/28°/36°
 调光控制 ON-OFF/DALI
 投射方向 水平350°, 垂直90°



订购模型请详见323页

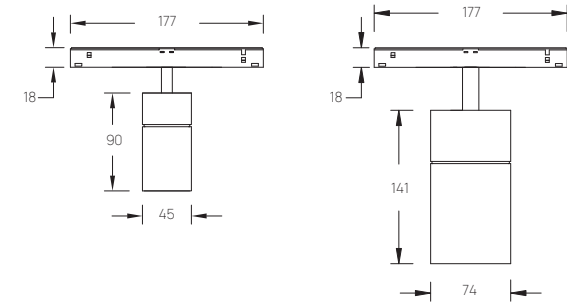

RTMA1S

RTMA1M

CECIO低压超薄轨道灯

主体材质 铝合金压铸灯体
 颜色 ● ○
 光源类型 COB
 光源功率 15W
 色温/显指 3000K/4000K, Ra90
 全光谱可变色温 (2700K-6500K), RA > 95
 电子变焦 全光谱可变色温 (2700K-6500K), RA > 95
 光源色容差 3 SDCM
 光源寿命 >36,000h-L70 / B10-Ta25°C(LM-80/TM-21)
 光学系统 透镜
 光束角 18°/28°/36°(3000K/4000K); 24°/36°(全光谱可变色温);
 电子变焦支持 20°-50°可调
 控制控制 DALI
 投射方向 水平 0°-355°调节, 竖直 0°-90°调节



订购模型请详见324页

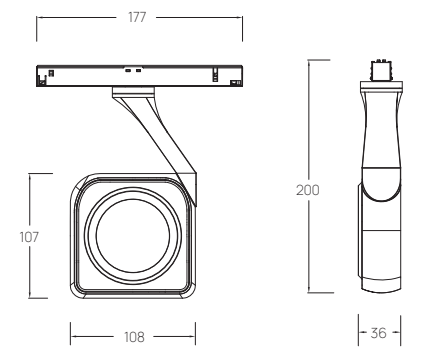
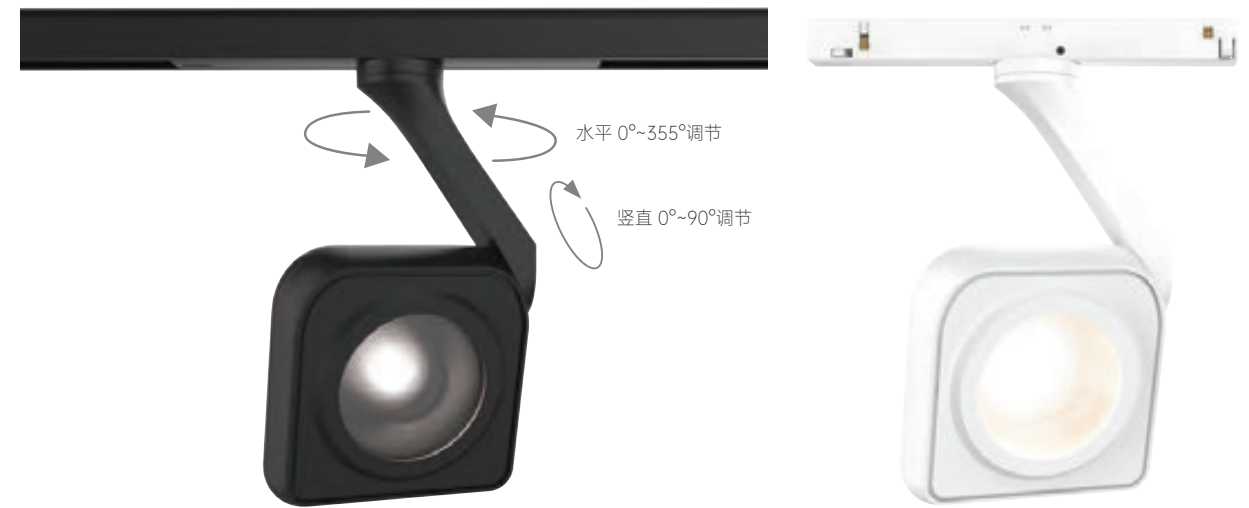

RTMA2M

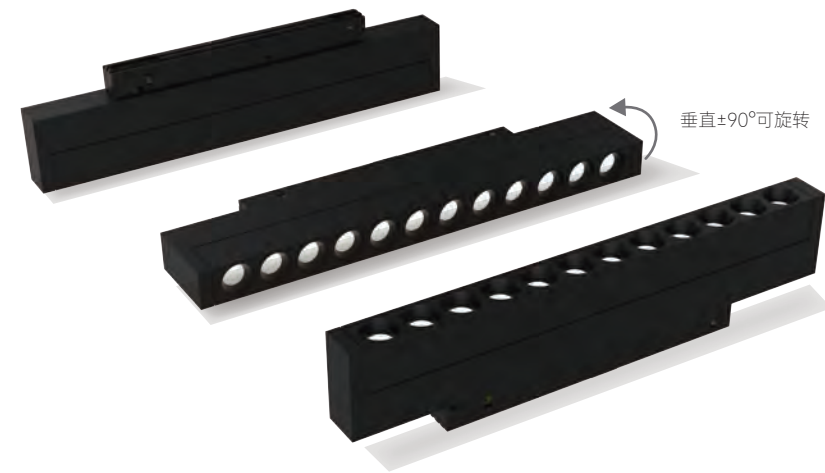

垂直±90°可旋转



垂直±90°可旋转

LA LÍNEA琳奈线条灯 调角

- 主体材质 优质铝合金材质
- 颜色 ●
- 光源类型 SMD
- 光源功率 271mm 10W/511mm 15W/751mm 20W
- 色温/显指 3000K/4000K, Ra > 90;
可变色温 (2700K-6500K), Ra > 90
- 光源色容差 3 SDCM
- 光源寿命 >36,000h-L70 / B10-Ta25°C(LM-80/TM-21)
- 光学系统 透镜+防眩格栅
- 光束角 36°/50°
- 调光控制 ON-OFF/DALI
- 投射方向 垂直±90°



订购模型请详见322页

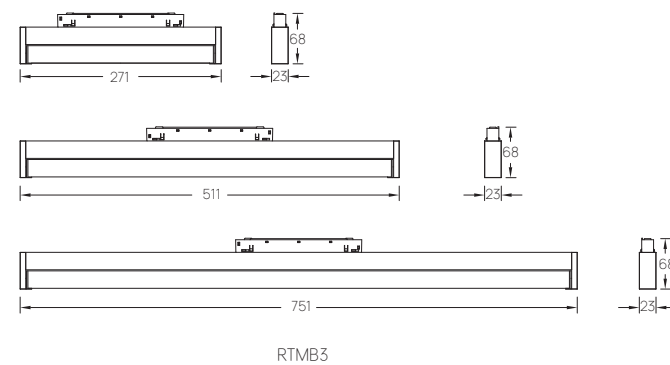

RTMB3

LA LÍNEA琳奈线条灯 下照

- 主体材质 优质铝合金材质
- 颜色 ●
- 光源类型 SMD
- 光源功率 243mm 10W/483mm 15W/723mm 20W
- 色温/显指 3000K/4000K, Ra > 90;
可变色温 (2700K-6500K), Ra > 90
- 光源色容差 3 SDCM
- 光源寿命 >36,000h-L70 / B10-Ta25°C(LM-80/TM-21)
- 光学系统 透镜+防眩格栅
- 光束角 36°/50°
- 调光控制 ON-OFF/DALI



订购模型请详见322页

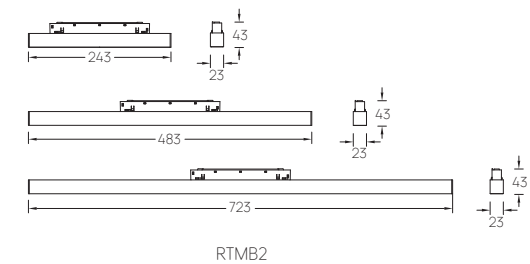

RTMB2



LA LÍNEA琳奈线条灯 面发光

主体材质 优质铝合金材质
 颜色 ●
 光源类型 SMD
 光源功率 195mm 10W/388mm 15W/579mm 20W
 色温/显指 3000K/4000K, Ra > 90;
 可变色温 (2700K-6500K), Ra > 90
 光源色容差 3 SDCM
 光源寿命 >36,000h-L70 / B10-Ta25°C(LM-80/TM-21)
 光学系统 亚克力扩散面罩
 光束角 面发光
 调光控制 ON-OFF, DALI



订购模型请详见322页



RTMB1M-20E-A30NBK



RTMB1S-15E-A30NBK



RTMB1N-10E-A30NBK

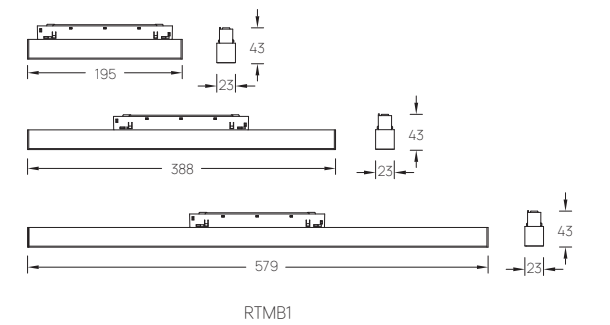

RTMB1



LA LÍNEA琳奈线条灯 洗墙 调角

- 主体材质 优质铝合金材质
- 颜色 ●
- 光源类型 SMD
- 光源功率 10W/25W
- 色温/显指 可变色温 (2700K-6500K), Ra > 90
- 光源色容差 3 SDCM
- 光源寿命 >36000h-L70 /B10-Ta25°C(LM-80/TM-21)
- 光学系统 透镜+防眩格栅
- 光束角 Wall Washer
- 调光控制 DALI



订购模型请详见323页

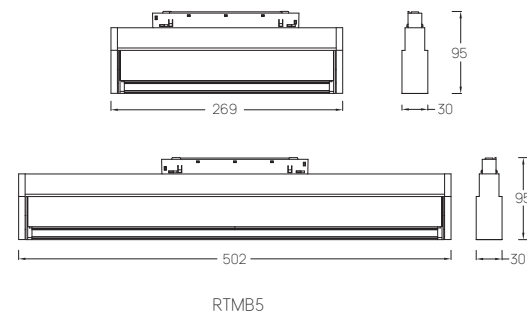

LA LÍNEA琳奈线条灯 洗墙

- 主体材质 优质铝合金材质
- 颜色 ●
- 光源类型 SMD
- 光源功率 10W/25W
- 色温/显指 可变色温 (2700K-6500K), Ra > 90
- 光源色容差 3 SDCM
- 光源寿命 >36000h-L70 /B10-Ta25°C(LM-80/TM-21)
- 光学系统 透镜+防眩格栅
- 光束角 Wall Washer
- 调光控制 DALI



订购模型请详见323页

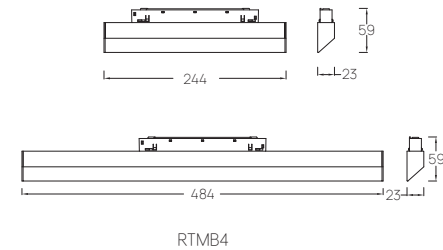



CELINE轨道吊灯

主体材质 优质铝合金材质
 颜色 ● ○
 光源类型 COB
 光源功率 10W
 色温/显指 3000K/4000K, Ra > 90;
 全光谱可变色温 (2700K-6500K), Ra > 95;
 光源色容差 3 SDCM
 光源寿命 >36,000h-L70 / B10-Ta25°C(LM-80/TM-21)
 光学系统 透镜+反射器
 光束角 18°/28°/36°
 调光控制 DALI



订购模型请详见324页

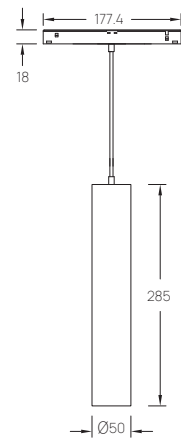

RTMC1S

CELINE轨道艺术吊灯

主体材质 优质铝合金材质
 颜色 ● ○
 光源类型 COB
 光源功率 10W
 色温/显指 3000K/4000K, Ra > 90;
 全光谱可变色温 (2700K-6500K), Ra > 95;
 光源色容差 3 SDCM
 光源寿命 >36,000h-L70 / B10-Ta25°C(LM-80/TM-21)
 光学系统 透镜+反射器
 光束角 18°/28°/36°
 调光控制 ON-OFF, DALI



订购模型请详见325页

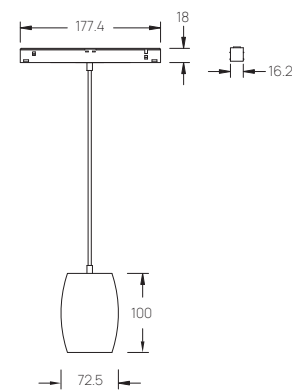

RTMC2S



CELINE轨道吊灯 8W/18W 带装饰头

主体材质 优质铝合金材质
 颜色 ● ○ ● ● ●
 光源类型 COB
 光源功率 8W/18W
 色温/显指 全光谱可变色温(2700K-6500K), RA > 95
 光源色容差 3 SDCM
 光源寿命 >36000h-L70 /B10-Ta25°C(LM-80/TM-21)
 光学系统 SUBROSA®隐光系统+可调焦透镜
 光束角 20°-50°
 遮光角 35°
 调光控制 DALI

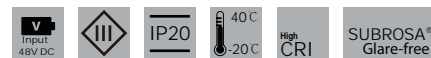

订购模型请详见325页

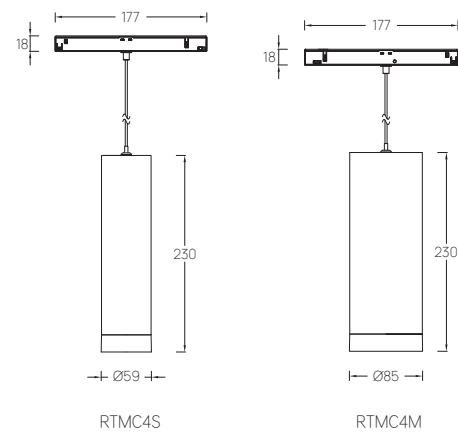

GENESIS水晶吊灯

主体材质 水晶灯罩、压铸铝灯身
 颜色 ●
 光源类型 SMD
 光源功率 上出光/下出光: 3W×5W
 色温/显指 3000K, Ra90
 光源色容差 5 SDCM
 光源寿命 >36000h-L70 /B10-Ta25°C(LM-80/TM-21)
 光学系统 透镜
 光束角 28°/36°/48°/≥100°
 调光控制 DALI



订购模型请详见325页

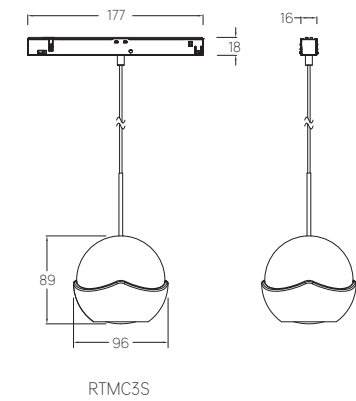

低压轨道配件搭配 造型百变

低压嵌入式轨道及配件

订购模型请详见363页



嵌入式轨道

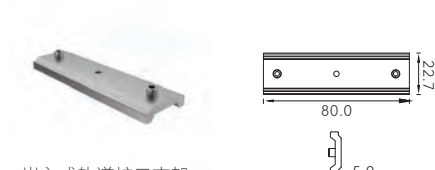

嵌入式轨道扩口支架

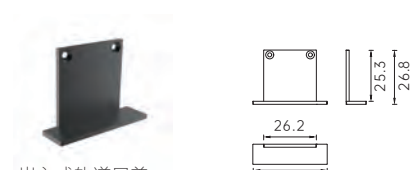

嵌入式轨道尾盖



嵌入式轨道扩口支架

低压嵌入式无边轨道及配件

订购模型请详见364-365页

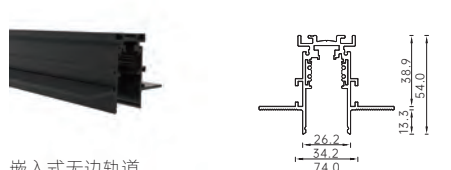

嵌入式无边轨道



嵌入式轨道连接片



嵌入式轨道黑色尾盖

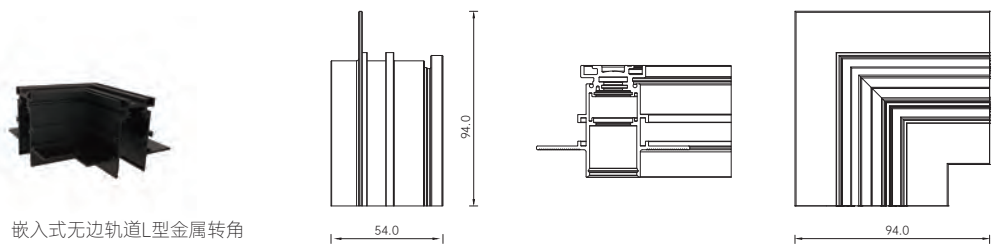

嵌入式无边轨道L型金属转角



嵌入式轨道安装拉手

嵌入式无边轨道外部垂直金属转角

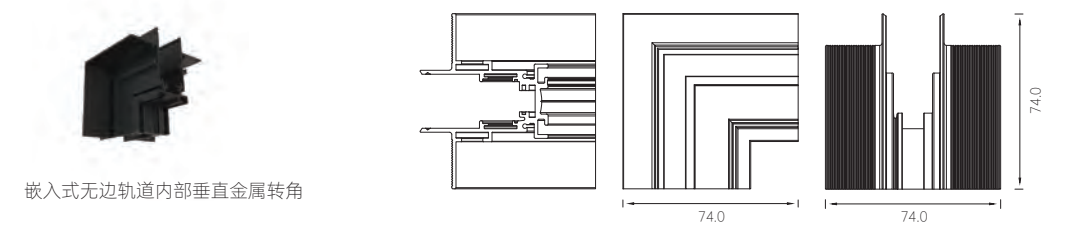

嵌入式无边轨道内部垂直金属转角

低压标准明装轨道及配件

订购模型请详见366页



标准明装轨道

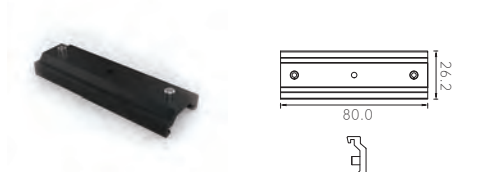

标准明装轨道扩口支架

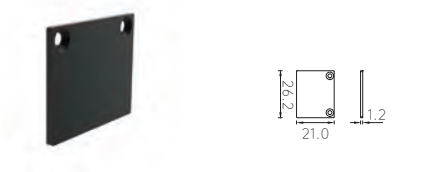

标准明装轨道尾盖

低压L型连接接驳配件

订购模型请详见365页

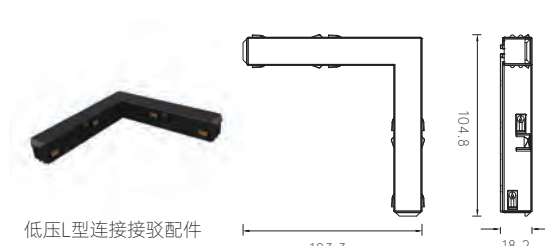

低压L型连接接驳配件

低压轨道软连接接驳配件

订购模型请详见365页



低压轨道软连接接驳配件

低压轨道进电端配件

订购模型请详见365页

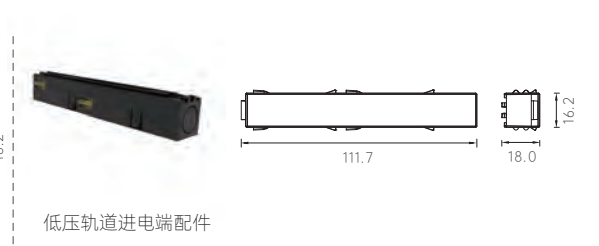

低压轨道进电端配件



LED柔性灯带

085-092P



ATMOSPHERE MAKER, WHICH CAN SATISFY PEOPLE'S SPIRITUAL
NEEDS VIA FOILING DIFFERENT ATMOSPHERES , EMOTIONS AND BACKGROUNDS.

气氛制造者

通过不同气氛的营造 情绪的调动 环境的烘托
满足人类精神层面的需求

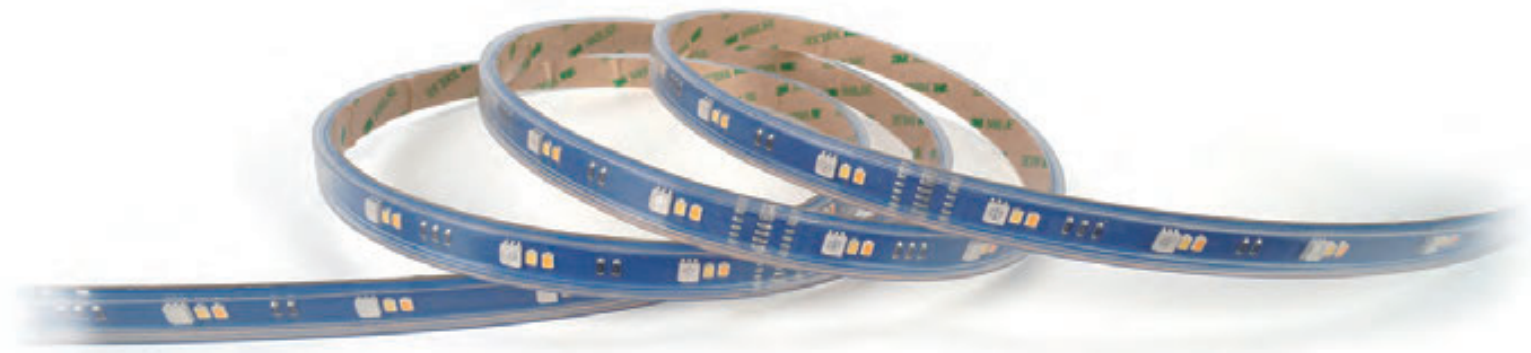
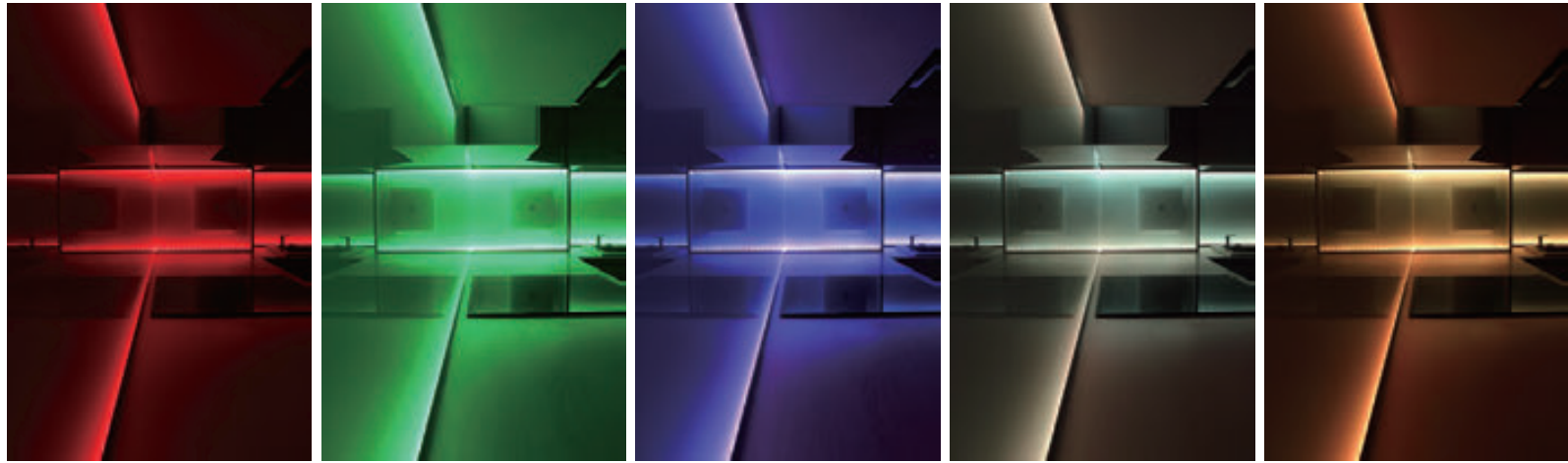

阑藤

主体材质 柔性铜质 FPCB 板, 优质硅胶套管
 光源类型 SMD
 光源功率 18W/M
 色温/显指 RGB+2400K+6000K
 光源色容差 5 SDCM
 光源寿命 >36000h-L70/B10-Ta25°C(LM-80/TM-21)
 光束角 ≥100°
 调光控制 搭配相应控制器可实现 0-10V、DMX512、DALI 等调光

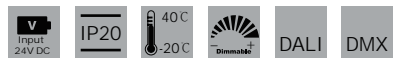

订购模型请详见326页 配件订购模型请详见366-367页

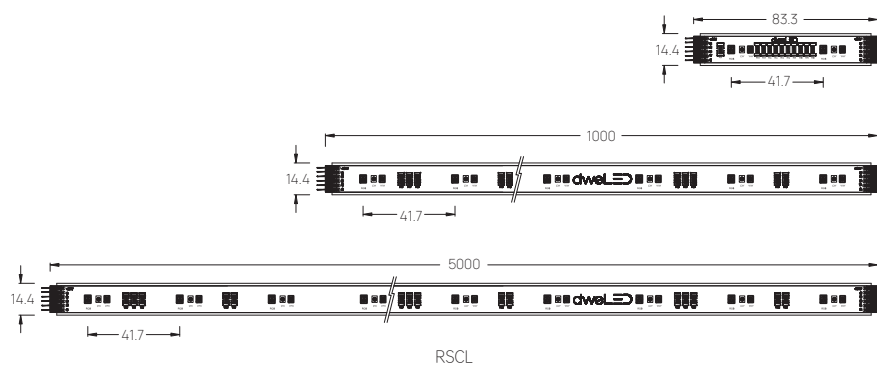

青藤

主体材质 柔性铜质 FPCB 板, 优质硅胶套管
 光源类型 SMD
 光源功率 20W/M
 色温/显指 2400K-6000K, Ra95
 光源色容差 5 SDCM
 光源寿命 >36000h-L70 / B10-Ta25°C(LM-80 / TM-21)
 光束角 ≥100°
 调光控制 搭配相应控制器可实现 0-10V、DMX512、DALI 等调光

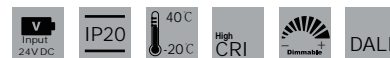

订购模型请详见326页 配件订购模型请详见366-367页

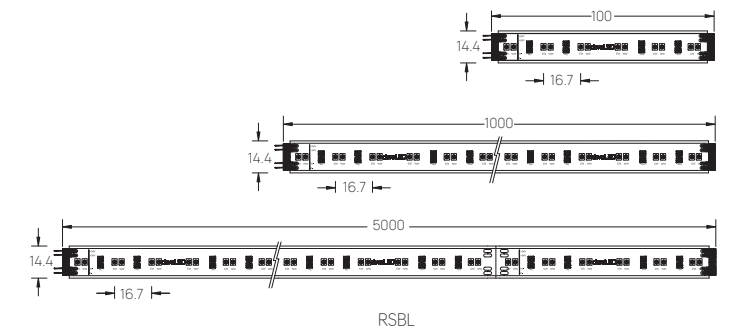



紫藤

主体材质 柔性铜质 FPCB 板, 优质硅胶套管
 光源类型 SMD
 光源功率 6W/M; 10W/M; 13W/M
 色温/显指 2700K/ 3000K/3500K/ 4000K, Ra95
 光源寿命 >36000h-L70/B10-Ta25°C(LM-80/TM-21)
 光源色容差 5 SDCM
 光束角 >100°
 调光控制 搭配相应控制器可实现 0-10V、DMX512、DALI 等调光

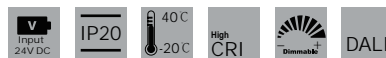

订购模型请详见326页 配件订购模型请详见366-367页

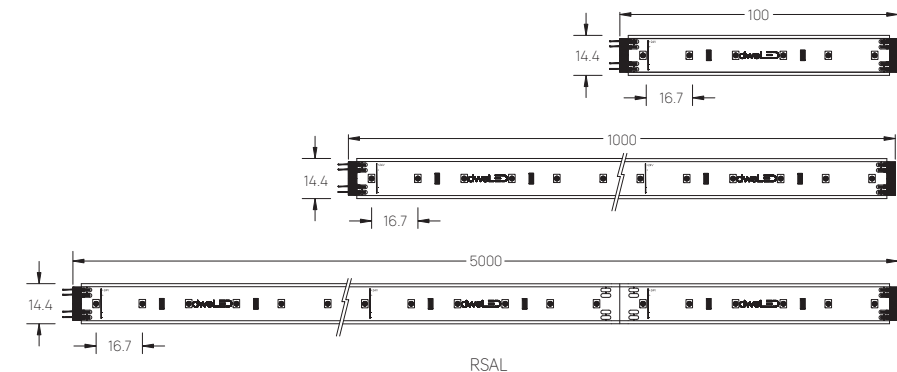

THE ART OF PERCEPTION RELIES ON LIGHT
EVENLY WASH THE CURTAINS LIKE A WATERFALL
GIVE THE SPACE SOME ARTISTIC FLAIR.

感知艺术依靠的是光线
如瀑布般均匀洗亮窗帘
给空间一些艺术感



线性明装灯具

093-096P



LA LÍNEA琳奈线条灯

主体材质 铝制灯身
 颜色 ● ○
 光源类型 SMD
 光源功率 4W/8W/16W
 色温/显指 3000K/4000K, Ra90
 光源色容差 5 SDCM
 光源寿命 >36000h-L70/B10-Ta25°C(LM-80/TM-21)
 光束角 28°/36°/48°
 调光控制 ON-OFF



订购模型请详见327页 配件订购模型请详见367页

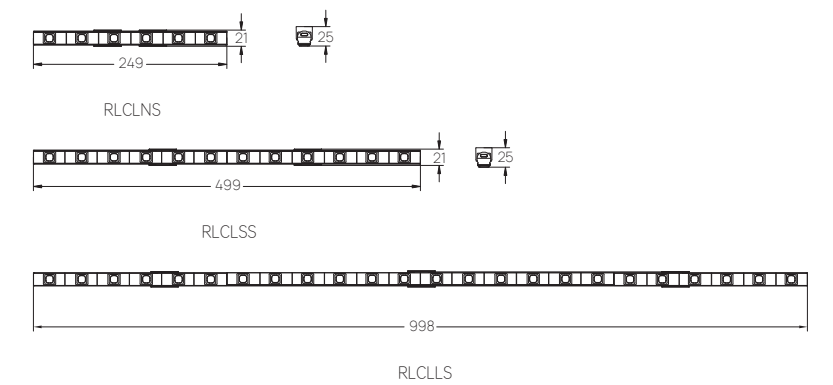
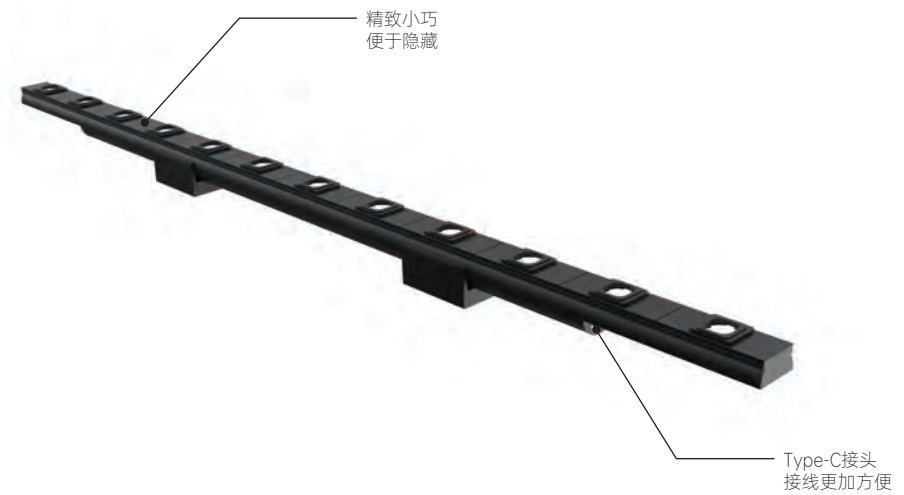



REVOKING PURE DESIGNS WITHOUT ANY DECORATION,
DISPLAY AESTHETICS AND VIGORS IN A CASUAL WAY.
唤醒纯粹不加以任何修饰的设计
让空间不经意间隐约透露出美感与力度



CELINE 8W/13W/25W

主体材质 铝合金挤出灯身
颜色 ● ○
光源类型 High Power LED(8W); COB(13W/18W/25W)
光源功率 HP LED 8W/COB 13W/COB 18W/COB 25W
光源光通量 800lm/8W 3000K; 1300lm/13W 3000K; 2500lm/25W 3000K
色温/显指 2700K/ 3000K/3500K / 4000K, Ra90
光源色容差 3 SDCM
光源寿命 >50000h-L70 /B10-Ta25°C(LM-80/TM-21)
光学系统 透镜+SUBROSA®隐光系统
光束角 15°/24°/36°/48°(8W); 20°/40°/60°(13W/18W/25W)
遮光角 35°
调光控制 ON-OFF

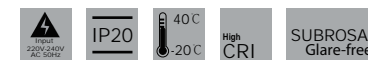

订购模型请详见327页

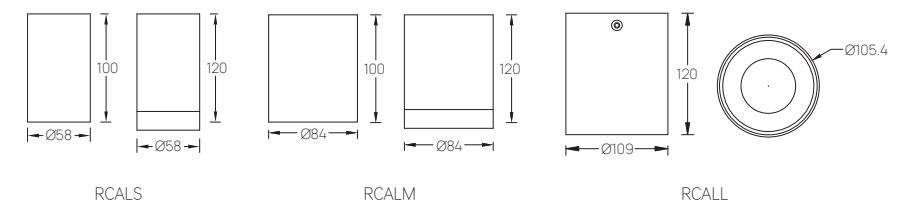



SIMPLE AND LUXURIOUS SUNFLOWER CURVE SHAPE, THE LIGHT IS EVEN AND SOFT.
 简约轻奢的太阳花曲线造型 出光均匀柔和



VAUGHAN

主体材质 铝制灯身 +PC 面罩
 颜色 ● ●
 光源类型 SMD
 光源功率 27W
 色温/显指 3000K, Ra90
 光源色容差 5 SDCM
 光源寿命 >36000h-L70 /B10-Ta25°C(LM-80/TM-21)
 光束角 ≥100°
 调光控制 ON-OFF



订购模型请详见328页

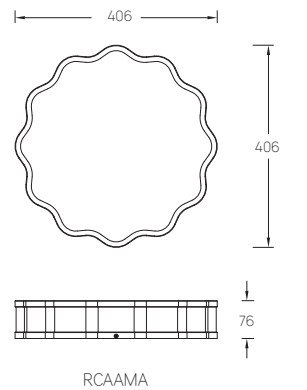



LIKE A MYSTERY WAITING TO BE SOLVED,
THE GLASS LAMP ILLUMINATES THE LIGHT,
EXUDES A SOFT AND WARM LIGHT, VERY ARTISTIC APPEAL.

像一个等待被揭开的谜团 玻璃灯罩包裹着光线
散发着柔和温馨的光 极具艺术感染力

BRANWEN

主体材质 吹制玻璃+铝制灯身
颜色 ●
光源类型 SMD
光源功率 5W
色温/显指 3000K, Ra90
光源色容差 5 SDCM
光源寿命 >36000h-L70/B10-Ta25°C(LM-80/TM-21)
光束角 ≥100°
调光控制 ON-OFF



订购模型请详见328页

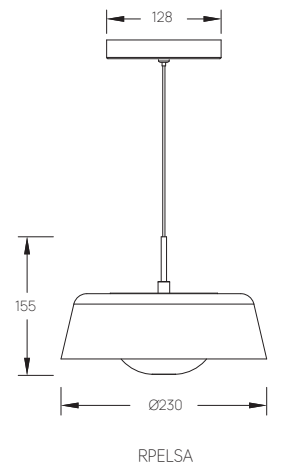



UNIQUE OVAL GLASS PENDANT WITH ACRYLIC GLOW STICK
 DRAMATIC AND CHARMING.
 独特的椭圆形玻璃吊坠搭载亚克力发光棒
 具有戏剧性和魅力

BOLLA

主体材质 吹制玻璃+铝制灯身
 颜色 ●
 光源类型 SMD
 光源功率 4W
 色温/显指 3000K, Ra90
 光源色容差 5 SDCM
 光源寿命 >36000h-L70/B10-Ta25°C(LM-80/TM-21)
 光束角 ≥100°
 调光控制 ON-OFF



订购模型请详见328页

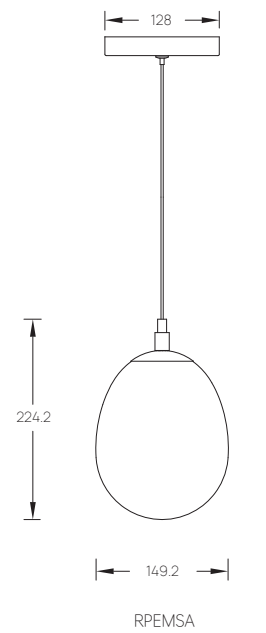



ELEGANT DESIGN, TWO-WAY LIGHT OUTPUT.
优雅的设计 双向出光的光效

TIC TOC

主体材质 铝制灯身
颜色 ●
光源类型 SMD
光源功率 8W
色温/显指 3000K, Ra90
光源色容差 5 SDCM
光源寿命 >36000h-L70/B10-Ta25°C(LM-80/TM-21)
光束角 >100°
调光控制 ON-OFF



订购模型请详见329页

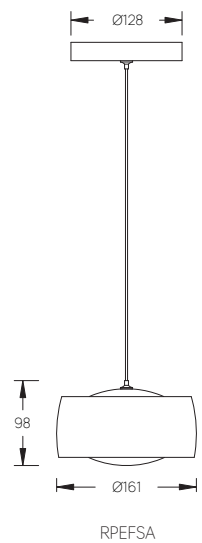
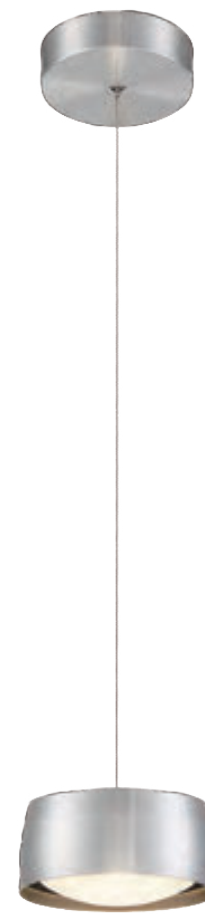



CHANDRA

主体材质 铝制灯身+玻璃灯罩
 颜色 ● ●
 光源类型 SMD
 光源功率 7W
 色温/显指 5 SDCM
 光源色容差 3000K, Ra90
 光源寿命 >36000h-L70/B10-Ta25°C(LM-80/TM-21)
 光束角 >100°
 调光控制 ON-OFF



订购模型请详见329页

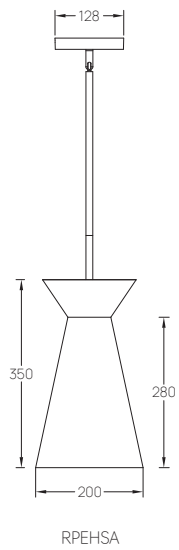



LIKE A CHARMING OPAL GEMSTONE WITH A SOFT, WARM GLOW.
似一颗迷人蛋白石宝石 散发着柔和温馨的光



LAUREL

主体材质 铝制灯身
颜色 ● ●
光源类型 SMD
光源功率 11W
色温/显指 3000K, Ra90
光源色容差 5 SDCM
光源寿命 >36000h-L70/B10-Ta25°C(LM-80/TM-21)
光束角 ≥100°
调光控制 ON-OFF



订购模型请详见329页

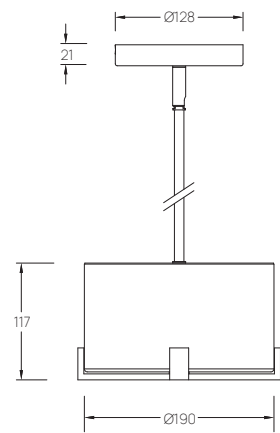

RPENSA



A GEM OF MINIMALISM, LIKE A SPARKLING DIAMOND,
SLIM LINE DESIGN DAZZLES AT EVERY ANGLE.

极简主义的瑰宝 就像闪闪发光的钻石
纤细的线条设计在各个角度炫耀光彩

CHRYSALIS

主体材质 铝制灯身+玻璃面罩
颜色 ● ●
光源类型 SMD
光源功率 4W
色温/显指 3000K, Ra90
光源色容差 5 SDCM
光源寿命 >36000h-L70/B10-Ta25°C(LM-80/TM-21)
光束角 >100°
调光控制 ON-OFF



订购模型请详见329页

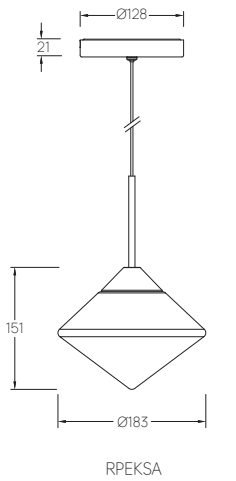

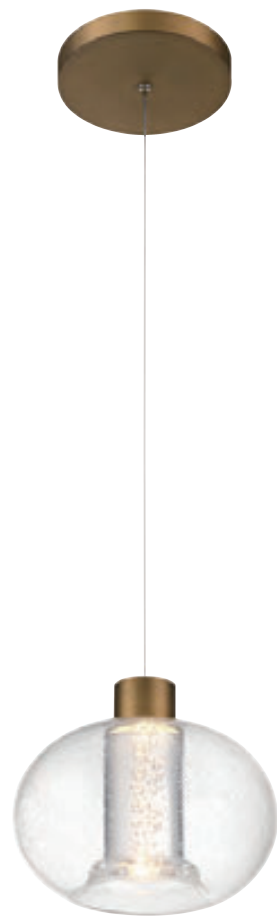

CRATER

主体材质 吹制玻璃+铝制灯身
 颜色 ●
 光源类型 SMD
 光源功率 3W
 色温/显指 3500K, Ra90
 光源色容差 5 SDCM
 光源寿命 >100°
 光束角 >36000h-L70/B10-Ta25°C(LM-80/TM-21)
 调光控制 ON-OFF



订购模型请详见330页

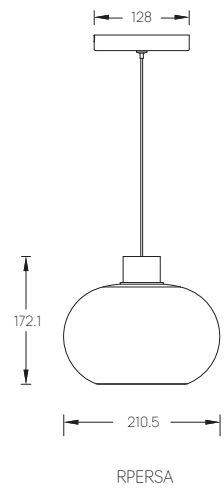

THE RISING OXYGEN BUBBLES,
 CREATE A DREAMY BEAUTY OF STILLNESS AND MOVEMENT.
 似上升的氧气气泡
 创造静中有动的梦幻美感



METAL DROPLET DESIGN IS BOTH MODERN AND FUTURISTIC.
金属液滴设计 既现代又充满未来感

ACTION

主体材质 铝制灯身+亚克力灯头
颜色 ● ● ●
光源类型 COB
光源功率 6W
色温/显指 3000K, Ra90
光源色容差 5 SDCM
光源寿命 >36000h-L70/B10-Ta25°C(LM-80/TM-21)
光束角 >100°
调光控制 ON-OFF



订购模型请详见330页

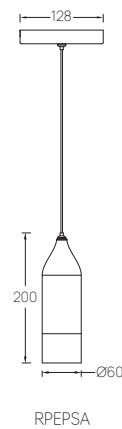



NAPA

- 主体材质 铝制灯身
- 颜色 ●
- 光源类型 SMD
- 光源功率 10W
- 色温/显指 3000K, Ra90
- 光源色容差 5 SDCM
- 光源寿命 >36,000h-L70 / B10-Ta25°C(LM-80/TM-21)
- 光束角 ≥100°
- 调光控制 ON-OFF

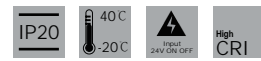

订购模型请详见330页

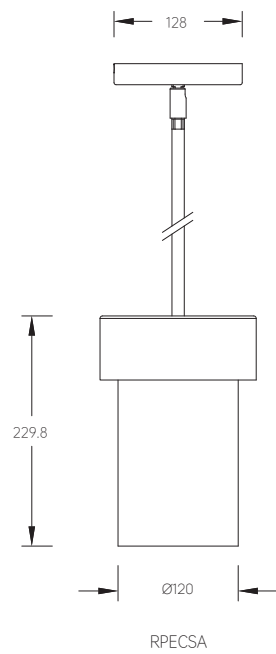

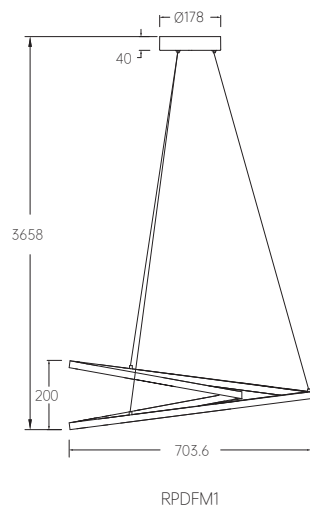

MARQUES

- 主体材质 铝制灯身
- 颜色 ● ●
- 光源类型 SMD
- 光源功率 35W
- 色温/显指 3000K, Ra90
- 光源色容差 5 SDCM
- 光源寿命 >100°
- 光束角 >36,000h-L70 / B10-Ta25°C(LM-80/TM-21)
- 调光控制 ON-OFF

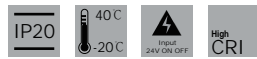

订购模型请详见330页





INTEGRATED SHAPE WITH MINIMALISM,
THROUGH WHICH LUXURY AND VOGUE CAN BE
OBSERVED.
一体化的造型
简约中透着奢华与时尚



MARQUES

主体材质 铝制灯身
颜色 ● ●
光源类型 SMD
光源功率 35W
色温/显指 3000K Ra90
光源色容差 5 SDCM
光源寿命 >36,000h-L70 / B10-Ta25°C(LM-80/TM-21)
光束角 ≥100°
调光控制 ON-OFF



订购模型请详见331页

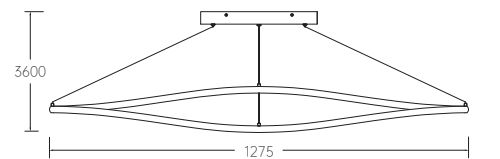

RPDFM2



DISENGAGE OSTENTATIOUS FLEXIBILITY,
THE WARM AND LOW-PROFILE COLOR WILL BE PRESENTED.
卸去浮华的灵动 色彩温润低调

ECHO

主体材质 铝制灯身+玻璃面罩
颜色 ●
光源类型 SMD
光源功率 7W
色温/显指 3000K, Ra90
光源色容差 5 SDCM
光源寿命 >36,000h-L70 / B10-Ta25°C(LM-80/TM-21)
光束角 >100°
调光控制 ON-OFF



订购模型请详见331页



人工吹制玻璃工艺
晶莹通透

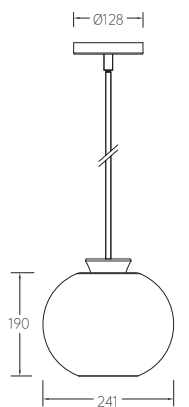

RPBFM2



WITHIN LIFE AMID ARTS,
FLEXIBLE AND INTELLIGENT MINIMALIST BUT STYLISH.

生活之内 艺术之中
自由灵动 极简显格调

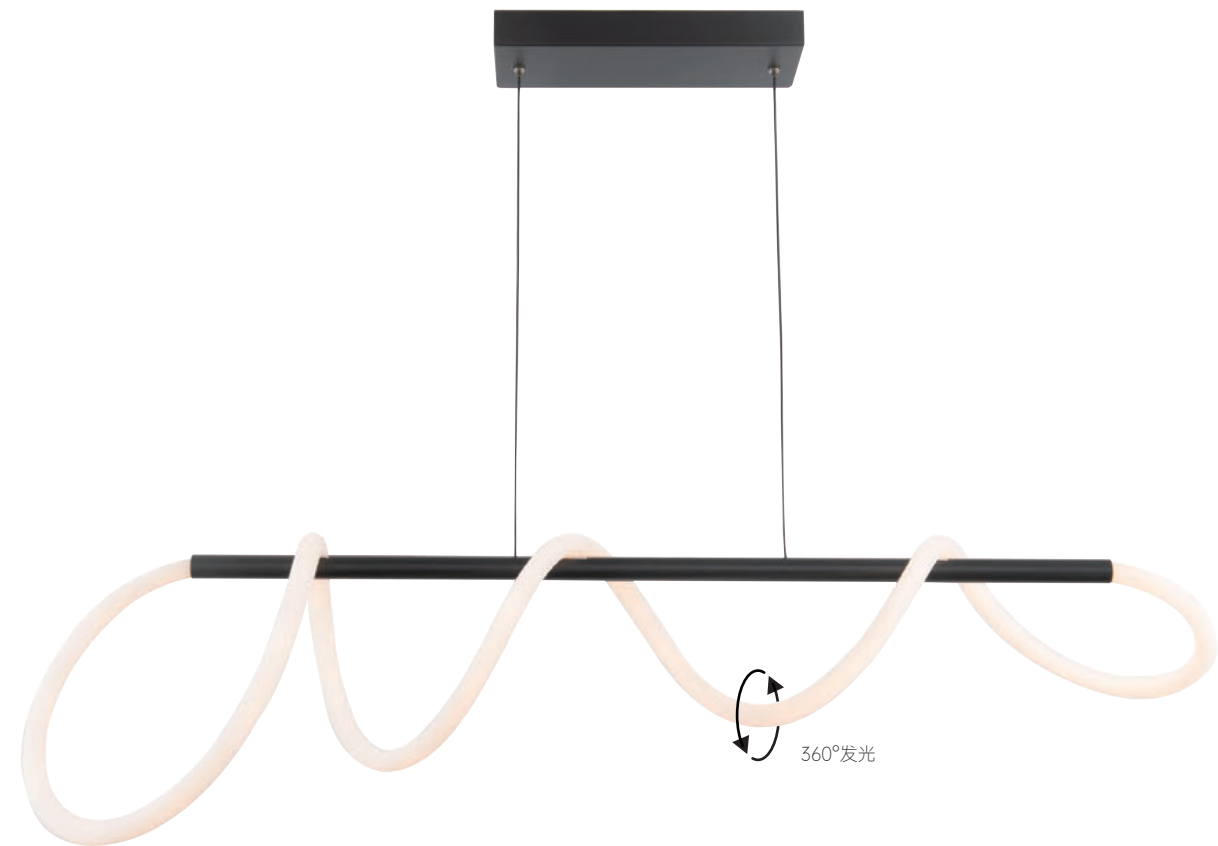

TIGHTROPE

主体材质 铝制灯身+玻璃面罩
颜色 ●
光源类型 SMD
光源功率 25W
色温/显指 3000K, Ra90
光源色容差 5 SDCM
光源寿命 >36000h-L70 /B10-Ta25°C(LM-80/TM-21)
光束角 ≥100°
调光控制 ON-OFF



订购模型请详见331页

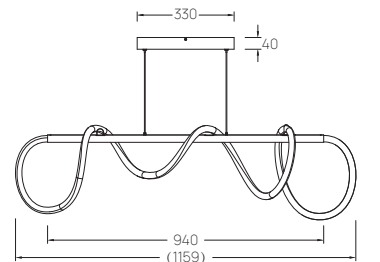

RPDFM3



CRYSTAL CARVING IS APPLIED IN ACRYLIC CRAFTSMANSHIP,
HENCE THE SPLENDID ILLUMINATION IS GLITTERING AND TRANSLUCENT,
AND THE LIGHT PERCEPTION IS COMFY.

晶雕亚克力工艺 出光晶莹绚烂 光感宜人舒适



EFFERVESCENT

主体材质 铝合金压铸灯身+亚克力玻璃
颜色 ● ● ●
光源类型 SMD
光源功率 25W
色温/显指 3000K, Ra90
光源色容差 5 SDCM
光源寿命 >36000h-L70/B10-Ta25°C(LM-80/TM-21)
光束角 ≥100°
调光控制 ON-OFF



订购模型请详见331页

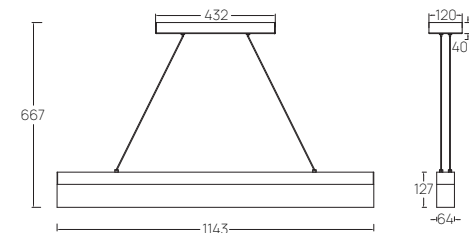

RPDLM1



CENTURY BREAKTHROUGH, THE TRANSMITTER OF ARTISTIC BEAUTY,
REGARDS THE EARTH AS ITS PROTOTYPE,
ABSORBING ELEMENTS OF CRYSTAL BUBBLES BETWEEN THE SKY AND GROUND.

创世纪 艺术美感的传递者
以地球为原型 苍穹与大地间
汲取天空与大地的元素水晶气泡



晶莹剔透
上下出光柔和均匀

GENESIS

主体材质 水晶灯罩、压铸铝灯身
颜色 ●
光源类型 SMD
光源功率 下出光5W, 上出光3W
色温/显指 3000K, Ra90
光源色容差 5 SDCM
光源寿命 >36,000h-L70 /B10-Ta25°C(LM-80/TM-21)
光学系统 透镜
光束角 28°/36°/48°/≥100°
调光方式 220V 支持 0-10V 调光/24V ON-OFF



订购模型请详见332页

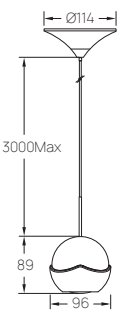

RPBDSA

CONCISE AND REFINING SHAPE DESIGN COUPLES WITH WARM AND COLD LIGHTING COLORS,
PRODUCING GORGEOUS HALO.

简明精炼的外型设计 搭配冷暖自如的光色 产生极美的光晕



LORA 16W/25W

主体材质 铝合金
颜色 ● ○ ● ●
光源类型 全光谱LED
光源功率 16W/25W
色温/显指 2700K-4000K可调, Ra95
光源寿命 >20000h-L70 /B10-Ta25°C(LM-80/TM-21)
光束角 >100°
调光控制 APP 控制/墙壁开关/Wi-Fi 组网
投射方向 下照



订购模型请详见332页

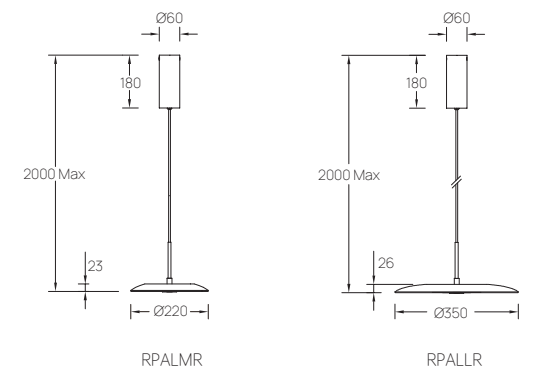

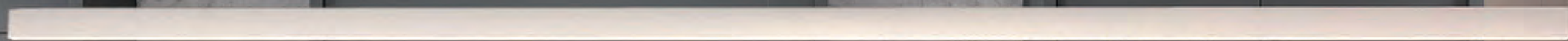

THE CHARISMA OF LINES LIES IN THEIR CHANGEABILITY,
TOGETHER, THEY CONSTITUTE AN AFFLUENT PLAT SURFACE,
HARMONIOUS COLORS WILL BE CONSTRUCTED WHILE AT THE SAME TIME
PRACTICAL FUNCTIONS WILL BE EQUIPPED.
WHETHER FOR SKETCHING THE OUTLINE OF SPACE OR SWITCHING FUNCTIONS,
HIGH QUALITY VISUAL IMPACT IS CONSTANTLY MAINTAINED BY LA LÍNEA.

线条的魅力在于它的多变
当聚在一起就构成了丰富的平面
在碰撞出和谐色彩的同时具有实用的功能
无论是勾勒空间 还是功能的转换
LA LÍNEA始终保持高品质的视觉震撼



LA LÍNEA琳奈 50W/64W

主体材质 铝合金挤出灯身
 颜色 ● ○
 光源类型 SMD LED
 光源功率 50W/64W
 光源光通量 3000K 7680lm; 4000K 8320lm(64W)
 色温/显指 3000K/4000K, Ra90
 光源色容差 3 SDCM
 光源寿命 >50,000h-L70 /B10-Ta25°C(LM-80/TM-21)
 光学系统 透镜+防磁面板
 光束角 90°
 调光控制 蓝牙控制



订购模型请详见332-333页

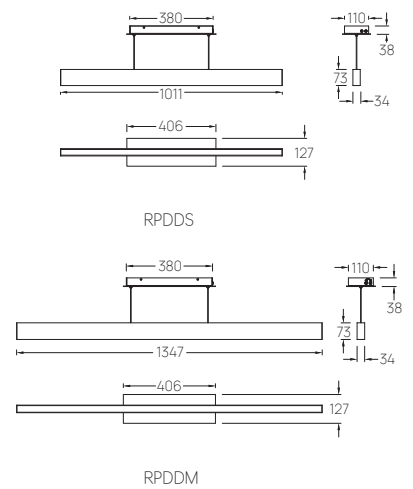
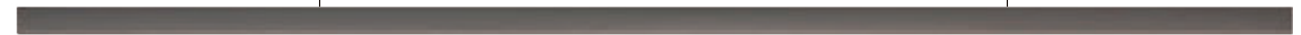



NEAT, CONCISE AND CLEAN LINES WITH DELICATE TEXTURE,
PURE SIMPLICITY IS BEAUTY.

利落 简洁的线条 细腻的质感 本我简单即是美

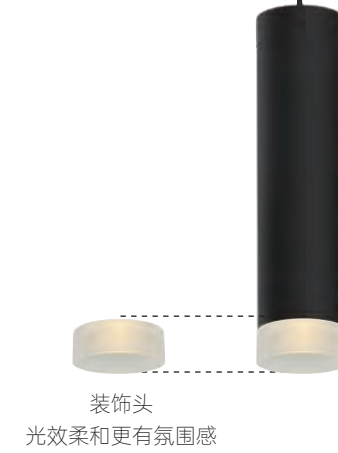

CELINE 8W/18W

主体材质 铝合金挤出灯身
颜色 ● ○ ● ● ●
光源类型 High Power LED(8W); COB(13W/18W)
光源功率 8W/13W/18W
色温/显指 2700K/ 3000K/ 3500K/ 4000K, Ra90
光源色容差 5 SDCM
光源寿命 >50,000h-L70 /B10-Ta25°C(LM-80/TM-21)
光学系统 SUBROSA®隐光系统+可调焦透镜
光束角 20°-50°
遮光角 35°
调光控制 ON-OFF

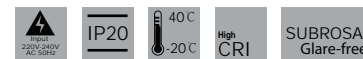

订购模型请详见333页

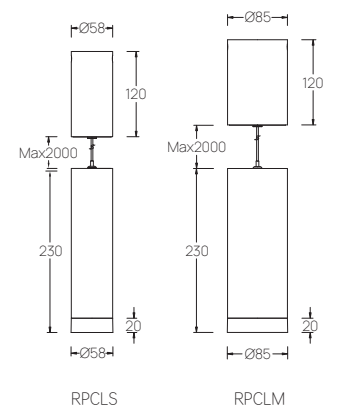



LET INNOVATION GET BACK TO ARTS, LET ARTS EMERGE WITH LIFE.
让创新回归艺术 艺术融于生活

ELLINGTON

主体材质 铝合金压铸灯身+吹制玻璃
颜色 ● ●
光源类型 COB
光源功率 5W
色温/显指 3000K, Ra90
光源色容差 5 SDCM
光源寿命 >36000h-L70/B10-Ta25°C(LM-80/TM-21)
光束角 ≥100°
调光控制 ON-OFF



订购模型请详见333页

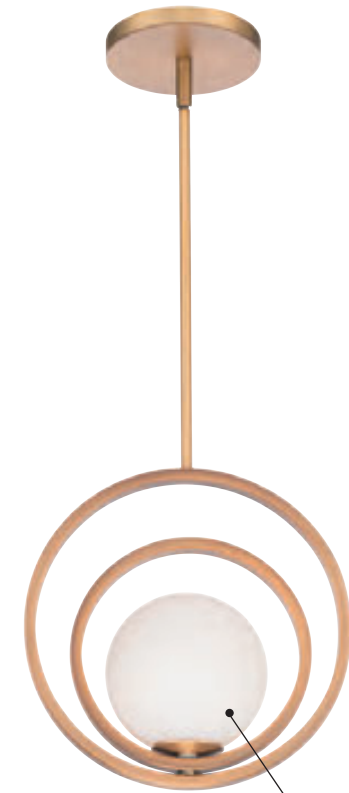

人工吹制白玉玻璃工艺

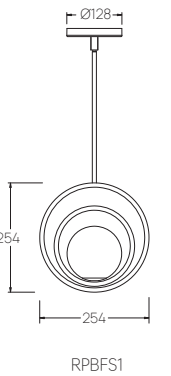



THE SIMPLER IT IS, THE MORE IMAGINATIVE IT IS,
UNDER ITS MINIMALIST SHAPE LIES THE TECHNICAL SUBLIMATION.
越简单 越有想象力
极简的外表下蕴含的是技术的升华





上出光营造氛围

下出光满足基础照明

LA LÍNEA PRO

主体材质 铝制灯身
 颜色 ●
 光源类型 SMD
 光源功率 上出光/下出光: 35W (2x17.5W)
 色温/显指 3000K-4000K-5000K, Ra90
 光源色容差 5 SDCM
 光源寿命 >36,000h-L70 / B10-Ta25°C(LM-80/TM-21)
 光学系统 透镜+反射器
 光束角 ≥100°
 控制方式 Gesture sensor

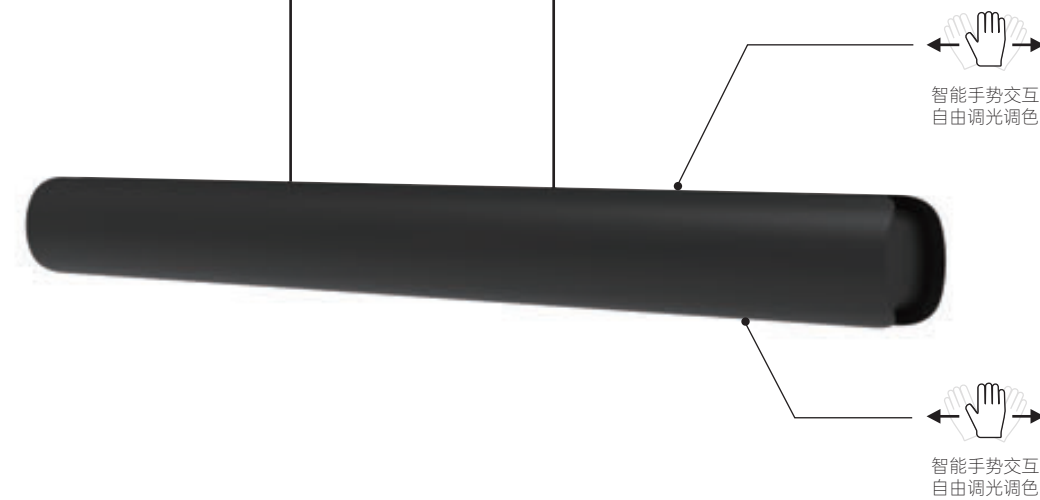
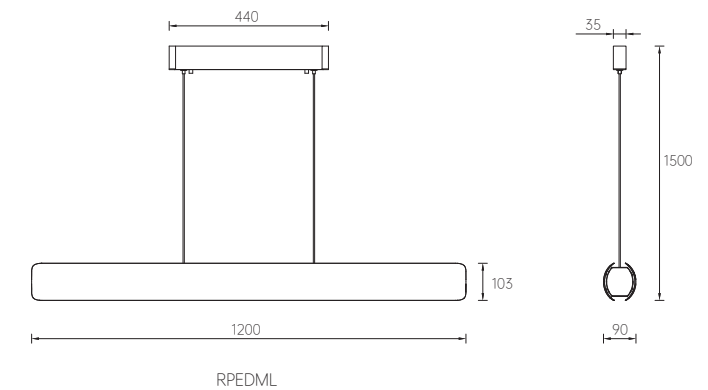

订购模型请详见334页

智能手势交互
自由调光调色智能手势交互
自由调光调色



吊灯配件

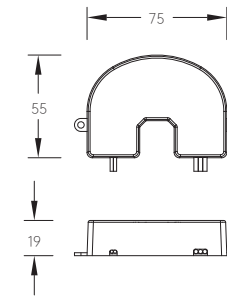

24V恒压电源

主体材质 塑胶外壳
光源功率 20W Max
控制方式 ON-OFF



订购模型请详见367页

可适用灯具

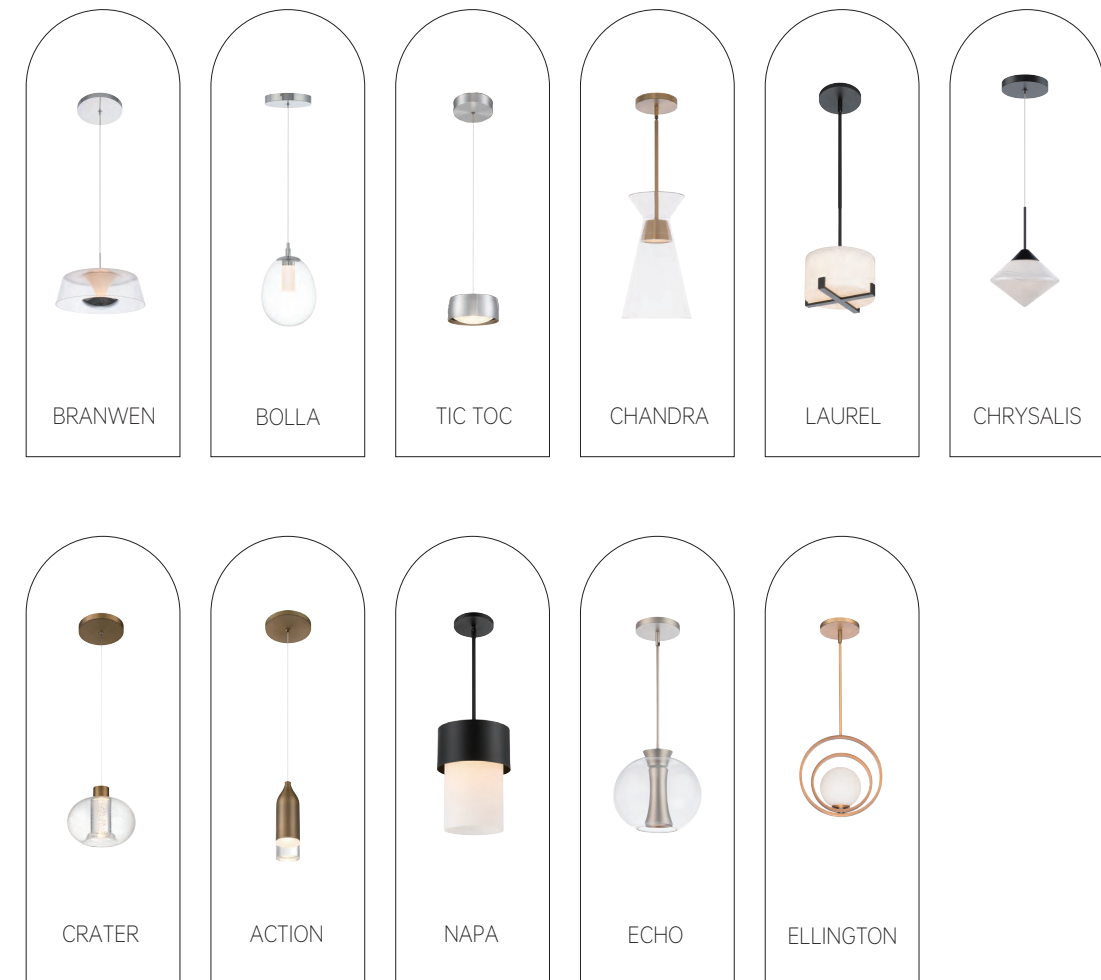



ROMANTIC POETRY,
STRETCHED PARABOLA EXTENDS TO THE PERIPHERY,
WHICH IS INTEGRATED WITH NATURAL LIGHT ARITHMETIC,
PRESENTING A HOMOGENEOUS ILLUMINATION EXPERIENCE.

浪漫的诗意
舒展的抛物线 蔓延至边界
结合自然光算法
呈现均匀一致的照明体验

LORA

主体材质 铝合金
颜色 白色
光源类型 全光谱 LED
光源功率 32W
光源光通量 1400lm/32W
色温/显指 2700K-4000K, Ra>95 连续可调色温
光源寿命 >20000h-L70 /B10-Ta25°C(LM-80/TM-21)
光束角 ≥100°
调光控制 脚踏式按键调光、APP控制、语音开关、WIFI组网
高度可调 1.4m-1.6m
投射方向 下照



订购模型请详见334页

语音控制

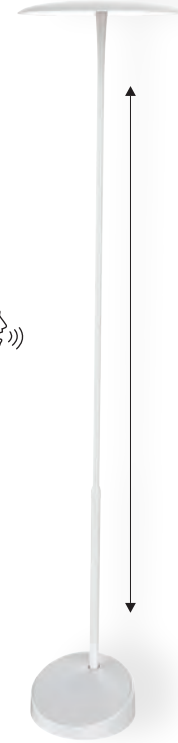

高度1.4m-1.6m可调

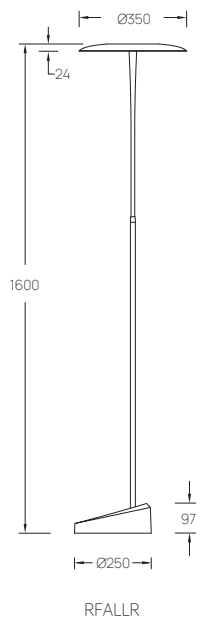

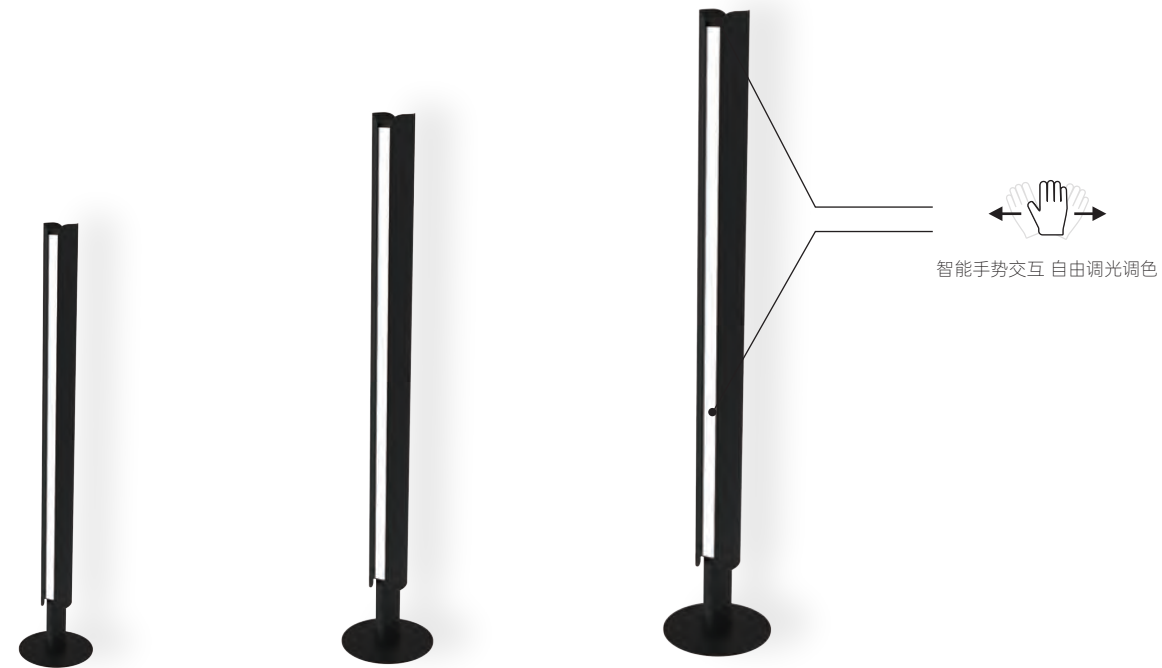

LA LÍNEA PRO

主体材质 铝制灯身
 颜色 ●
 光源类型 SMD
 光源功率 前出光/后出光: 20W (2×10W) ; 35W (2×17.5W) ; 45W (2×22.5)
 色温/显指 3000K-4000K-5000K, Ra90 色温可切换
 光源色容差 5 SDCM
 光源寿命 >36000h-L70 /B10-Ta25°C(LM-80/TM-21)
 光学系统 透镜+反射器
 光束角 >100°
 调光控制 Gesture sensor



订购模型请详见334-335页

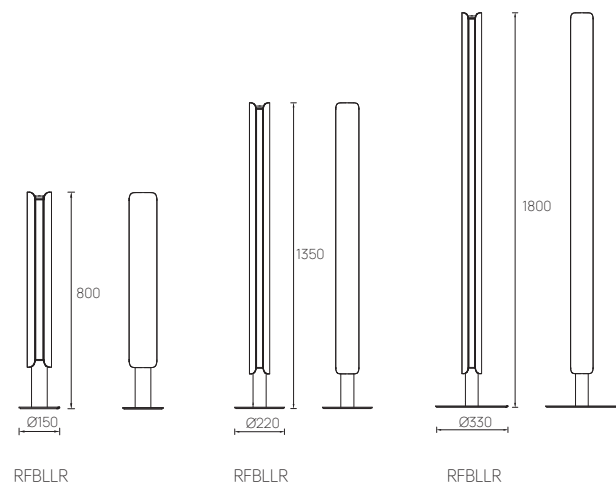

ENJOY INTELLIGENCE, SIMPLIFY LIFE,
 ARTISTIC BACKLIGHT DESIGN, EASILY FOIL ATMOSPHERE,
 SMART INTERACTIVE GESTURES, FREELY ADJUST COLOR AND BRIGHTNESS.

乐享智能 简化生活
 艺术背光设计 轻松营造氛围
 智能手势交互 自由调光调色

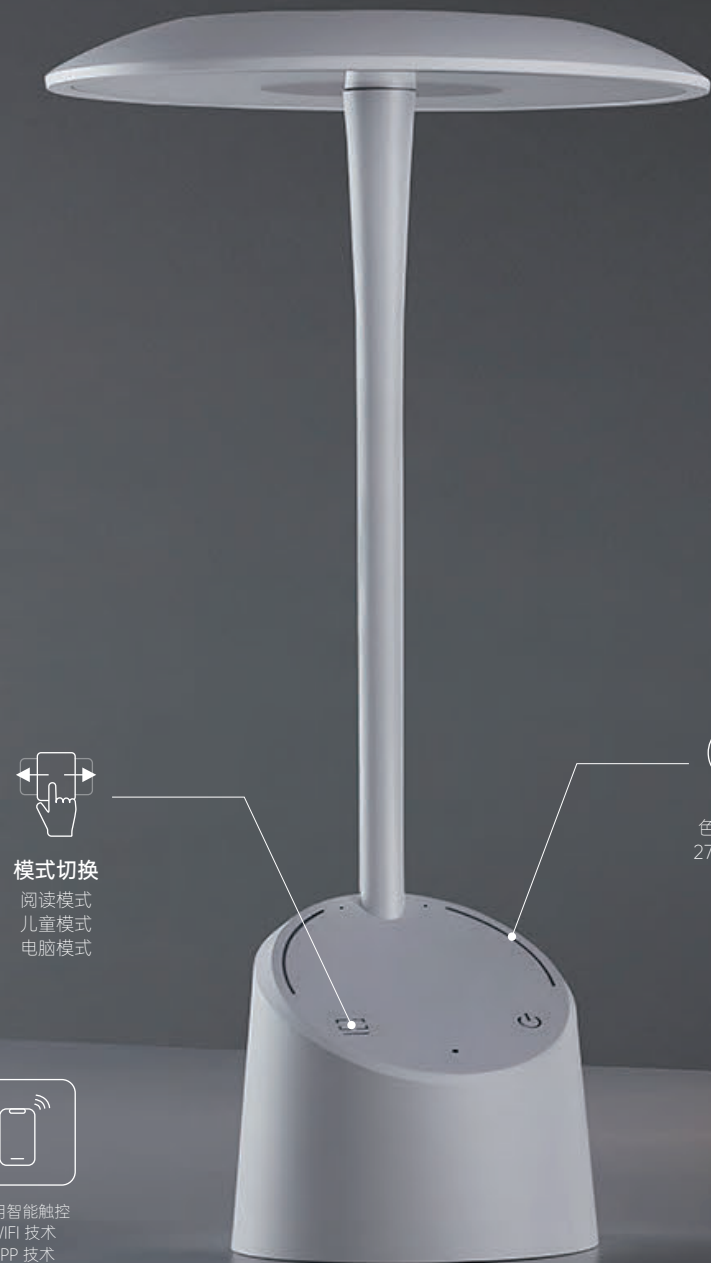

模式切换
阅读模式
儿童模式
电脑模式

色温滑动条
2700-4000K



舒展的抛物线
蔓延至边界戛然而止
使灯盘更加纤薄

语音控制



灯杆缓慢变窄的设计
让光更多的向下延伸
从而产生极美的光晕

亮度滑动条
30%-100%

触控底座反复打磨
平衡了触控舒适与安全
可以把它捧到手里



国AA级护眼台灯
全光谱
高品质LED光源
显色指数高达95
清晰呈现真实色彩
采用智能触控
WIFI 技术
APP 技术
语音控制技术
带来便捷舒适的操控体验



FUNCTION AND FORMAT, POEM AND TECHNIQUE,
HUMAN AND NATURE ORGANICALLY CONSTITUTE THE SUPERIOR LIGHT.
卓越的光是功能和形式诗歌和技术人类和自然的有机合成



LORA

主体材质 铝合金
颜色 ● ○ ● ●
光源类型 SMD
光源功率 20W
光源光通量 800lm
色温/显指 2700K-4000K, Ra>95
光源色容差 5 SDCM
光源寿命 >20000h-L70 / B10-Ta25°C(LM-80/TM-21)
光束角 >100°
调光控制 支持触摸控制、APP控制、语音开关、WIFI组网
投射方向 下照



订购模型请详见335页

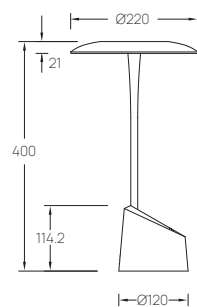

RRALM



THE ICONIC MINIMALIST ATTENTION TWO-WAY LIGHT EFFECT
MAKES THE HOME MORE TEXTURED.

标志性的极简主义 双向光效 让家更有质感

DUET

主体材质 铝制灯身
颜色 ○ ●
光源类型 SMD
光源功率 11W
色温/显指 3000K, Ra90
光源色容差 5 SDCM
光源寿命 >36000h-L70 /B10-Ta25°C(LM-80/TM-21)
光束角 >100°
调光控制 ON-OFF



订购模型请详见335页

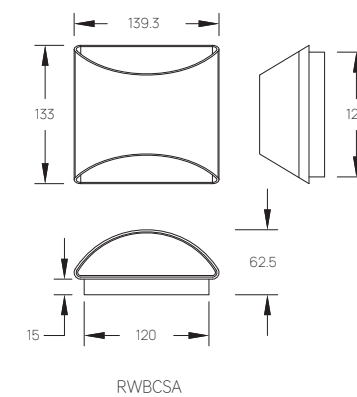

RWBCSA



LAYNE

主体材质 铝制灯身
 颜色 ●
 光源类型 SMD
 光源功率 7W
 色温/显指 2700K/3000K/3500K, Ra90
 光源色容差 5 SDCM
 光源寿命 >36000h-L70 /B10-Ta25°C(LM-80/TM-21)
 光束角 ≥100°
 调光控制 ON-OFF



订购模型请详见336页

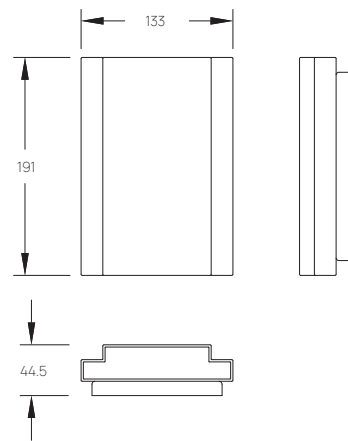

RWBFSA



BOLD AND UNASSUMING MODERN TASTE,
 TWO-WAY GRADIENT BEAM DESIGN.
 大胆不张扬的现代品味 双向渐变光束设计



SLEEPLESS

主体材质 铝制灯身+玻璃发光体
 颜色 ●
 光源类型 SMD
 光源功率 13W/17W
 色温/显指 3000K, Ra90
 光源色容差 5 SDCM
 光源寿命 >36000h-L70/B10-Ta25°C(LM-80/TM-21)
 光束角 ≥100°
 调光控制 ON-OFF

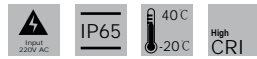

订购模型请详见336页

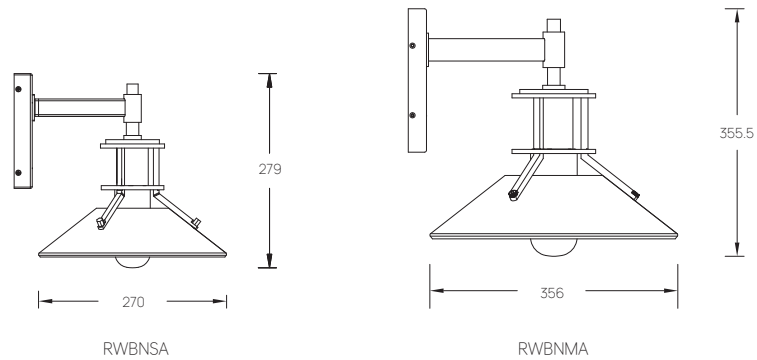

RETRO INDUSTRIAL STYLE, UNDERSTATED YET ELEGANT.
 复古工业风格 低调却不失雅致



FASHION AESTHETICS IN THE BLINK OF AN EYE,
ENHANCE THE SENSE OF LUXURY AND FASHION IN THE ROOM.
时尚的美学在眨眼之间 提升房间的轻奢时尚感

COLLETTE

主体材质 铝制灯身
颜色 ○ ● ● ● ●
光源类型 SMD
光源功率 10W
色温/显指 3000K, Ra90
光源色容差 5 SDCM
光源寿命 >36000h-L70 /B10-Ta25°C(LM-80/TM-21)
光束角 >100°
调光控制 ON-OFF



订购模型请详见336页

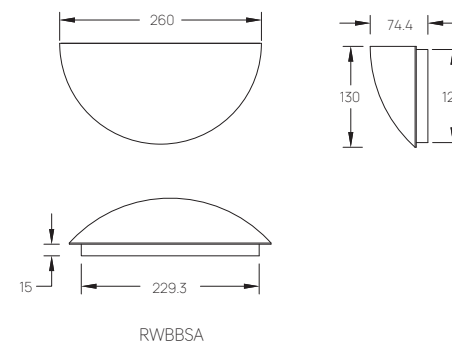



MYLIE

主体材质 铝制灯身+玻璃灯罩
 颜色 ● ●
 光源类型 SMD
 光源功率 13W
 色温/显指 3000K, Ra90
 光源色容差 5 SDCM
 光源寿命 >36000h-L70 /B10-Ta25°C(LM-80/TM-21)
 光束角 ≥100°
 调光控制 ON-OFF

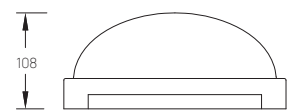
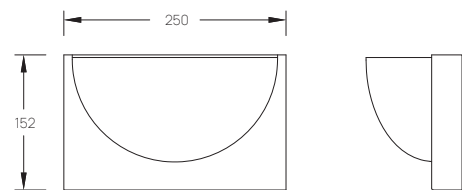

RWBKSA



FASHION AND EXQUISITE FAN
 DIFFUSE REFLECTION LIGHT MODE SOFT AND COMFORTABLE.
 时尚精致范 漫反射发光方式 柔和舒适



ARTISTIC TWO-WAY LIGHT EFFECT,
LOW-KEY AND RESTRAINED CURVE OUTLINE.
艺术性的双向光效 低调内敛的曲线轮廓



CORNICE

主体材质 铝制灯身
颜色 ○ ● ●
光源类型 SMD
光源功率 9W
色温/显指 3000K, Ra90
光源色容差 5 SDCM
光源寿命 >36000h-L70 /B10-Ta25°C(LM-80/TM-21)
光束角 ≥100°
调光控制 ON-OFF



订购模型请详见337页

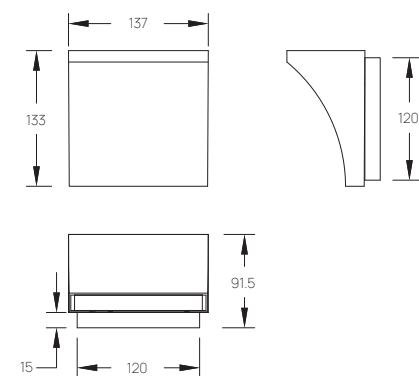

RWBASA



CAMELOT

主体材质 铁制灯身+磨砂亚克力灯罩
 颜色 ● ●
 光源类型 SMD
 光源功率 9W
 色温/显指 3000K, Ra90
 光源色容差 5 SDCM
 光源寿命 >36000h-L70 /B10-Ta25°C(LM-80/TM-21)
 光束角 ≥100°
 调光控制 ON-OFF



订购模型请详见337页

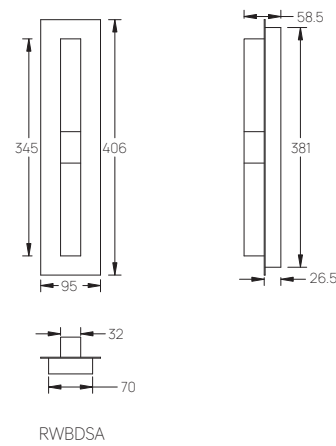

THE GEOMETRIC SHAPE CONNECTS THE LAMP BODY,
 CREATING A UNIQUE SENSE OF BALANCE.
 几何的形状连接灯体 创造出特有的平衡感



POCKET

主体材质 铝制灯身
 颜色 ● ○ ● ●
 光源类型 SMD
 光源功率 15W
 色温/显指 3000K, Ra90
 光源色容差 5 SDCM
 光源寿命 >36000h-L70 /B10-Ta25°C(LM-80/TM-21)
 光束角 >100°
 调光控制 ON-OFF



订购模型请详见337页

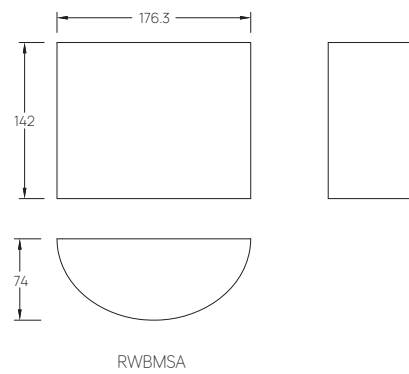

EYE-CATCHING CYLINDRICAL SHAPE, LIGHT LUXURY AND FASHION.
 引人注目的圆柱轮廓造型 轻奢时尚



BALANCE

主体材质 铝合金灯身
 颜色 ● ○ ●
 光源类型 SMD
 光源功率 8W
 色温/显指 3000K/4000K, Ra90
 光源色容差 5 SDCM
 光源寿命 >36000h-L70 /B10-Ta25°C(LM-80/TM-21)
 光束角 ≥100°
 调光控制 ON-OFF



订购模型请详见337页

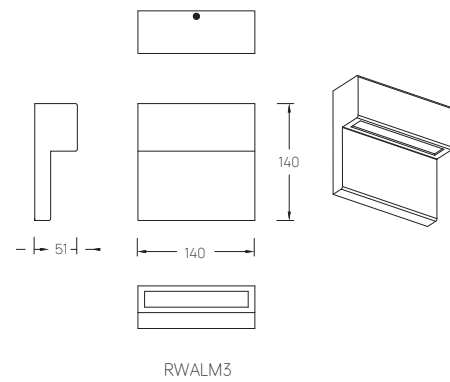

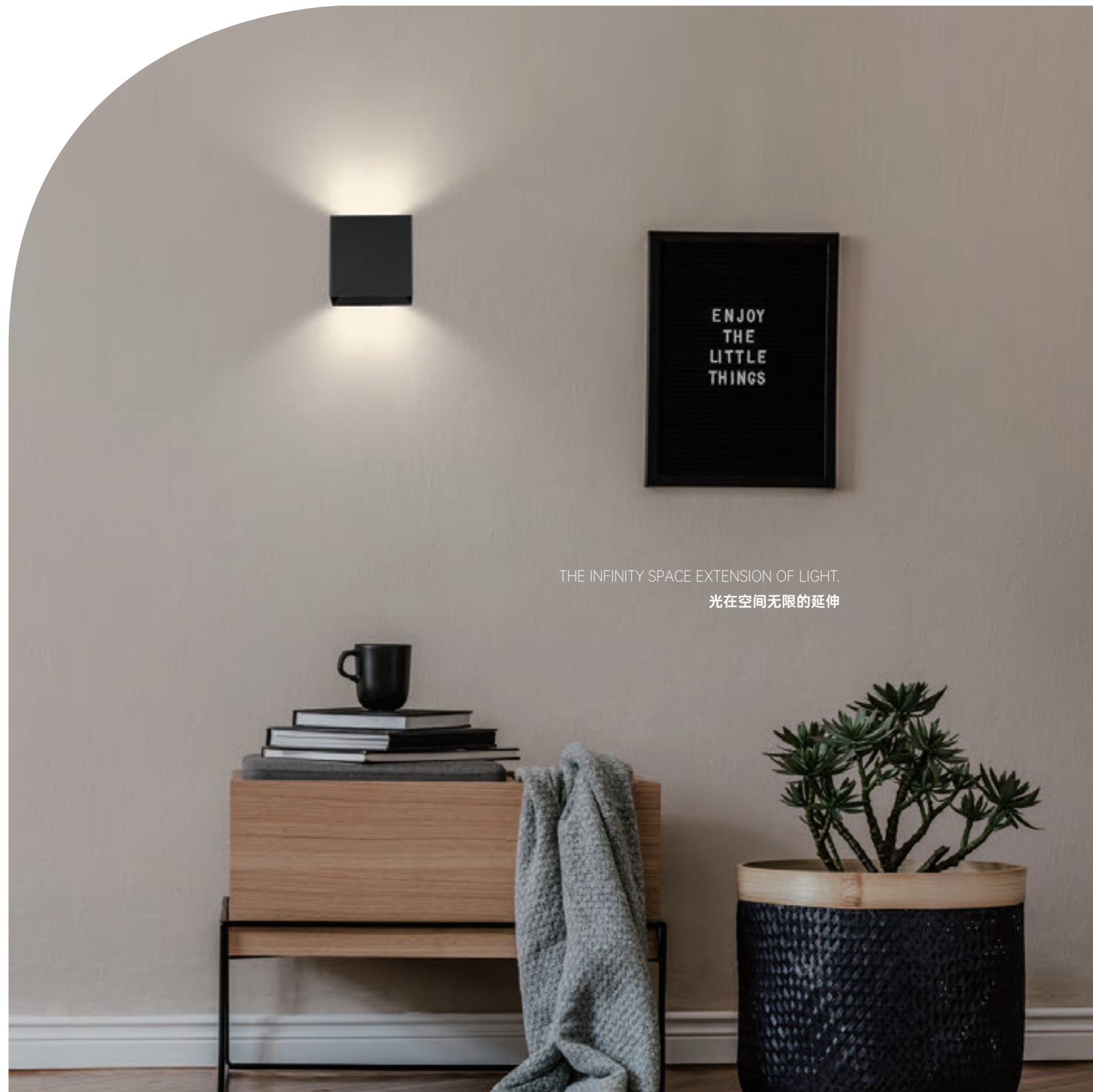

THE INFINITY SPACE EXTENSION OF LIGHT.
光在空间无限的延伸

BOXI

主体材质 铝合金灯身
颜色 ● ○
光源类型 SMD
光源功率 8W
色温/显指 3000K/4000K, Ra90
光源色容差 5 SDCM
光源寿命 >36000h-L70 /B10-Ta25°C(LM-80/TM-21)
光束角 >100°
调光控制 ON-OFF



订购模型请详见338页

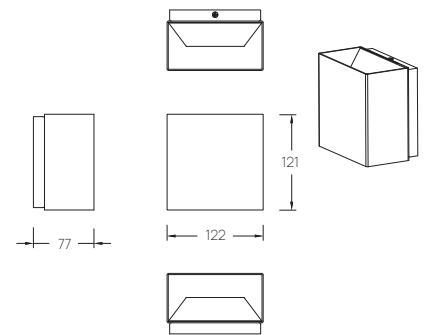
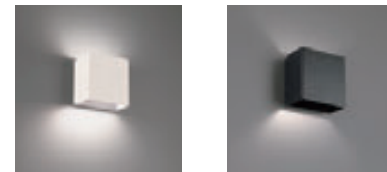

RWALM1



POLYGONAL DESIGN, ABUNDANT WITH STEREOSCOPIC AESTHETICS.
多边形设计 富有立体美感



ATLANTIS

主体材质 铝合金灯身
颜色 ● ○ ●
光源类型 SMD
光源功率 8W
色温/显指 3000K/4000K, Ra90
光源色容差 5 SDCM
光源寿命 >36000h-L70 /B10-Ta25°C(LM-80/TM-21)
光束角 >100°
调光控制 ON-OFF



订购模型请详见338页

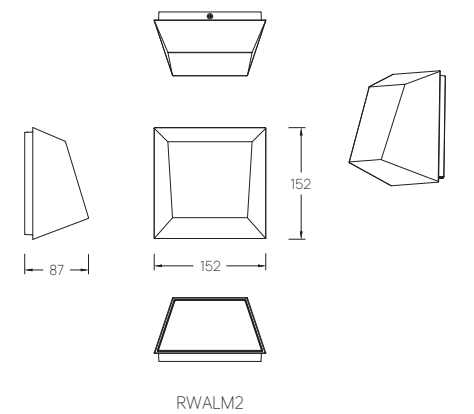

RWALM2



SAFE AND STYLISH, EMERGENCY BACKUP BATTERIES ARE
HIDDEN IN THE LAMPS.
安全时尚 灯具里隐藏紧急备用电池

BLOK

主体材质 铝制灯身
颜色 ● ○ ●
光源类型 SMD
光源功率 24W
色温/显指 2700K/3000K/3500K, Ra90
光源色容差 5 SDCM
光源寿命 >36000h-L70 /B10-Ta25°C(LM-80/TM-21)
光束角 >100°
调光控制 ON-OFF



订购模型请详见338页

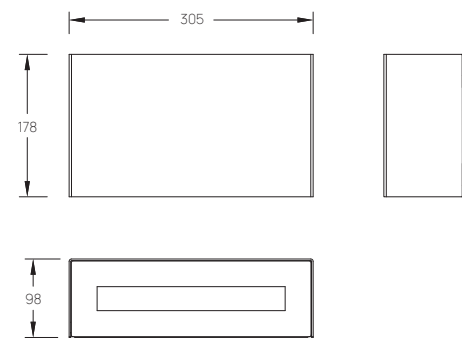

RWBLSA



CLASSIC AND MODERN DESIGN FRENCH ELEGANCE.
经典而现代的设计 法式优雅的格调

MAVEN

主体材质 铝制灯身+亚克力灯罩
颜色 ●
光源类型 SMD
光源功率 15W
色温/显指 3000K, Ra90
光源色容差 5 SDCM
光源寿命 >36000h-L70 /B10-Ta25°C(LM-80/TM-21)
光束角 ≥100°
调光控制 ON-OFF



订购模型请详见338页

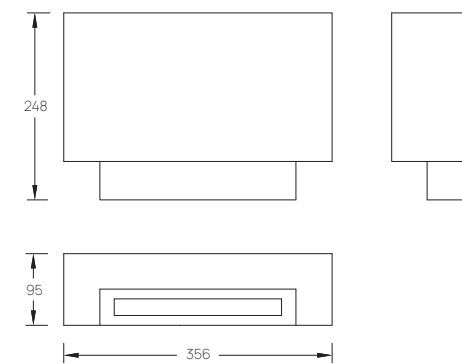

RWBISA



LIVE UP MINIMALISM TO THE EXTREME AESTHETICS,
THERE IS NO NEED TO FLAUNT.
将简约做到极致美感
不需要故意去标榜

PARALLAX

主体材质 铝制灯身
颜色 ● ● ● ●
光源类型 SMD
光源功率 6W
色温/显指 2700K/3000K/3500K, Ra90
光源色容差 5 SDCM
光源寿命 >36000h-L70 /B10-Ta25°C(LM-80/TM-21)
光束角 ≥100°
调光控制 ON-OFF



订购模型请详见339页

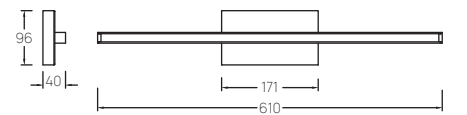
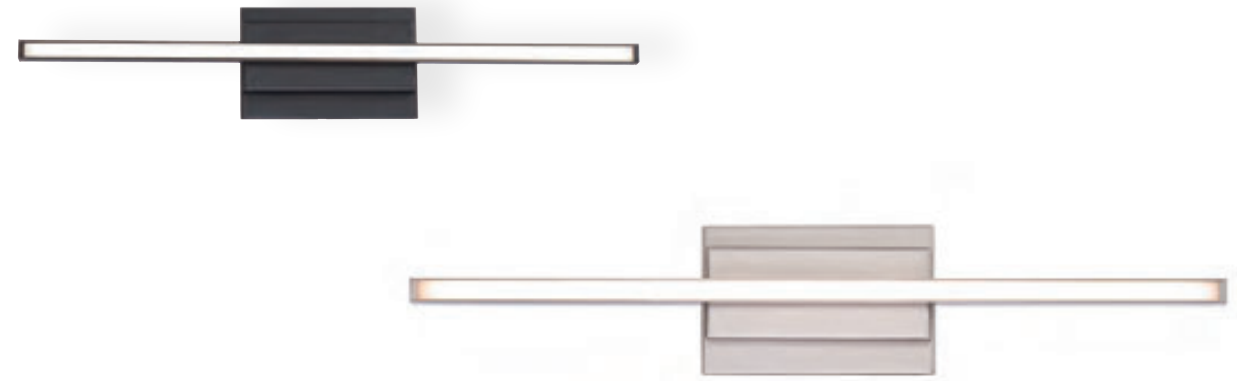

RWALM5

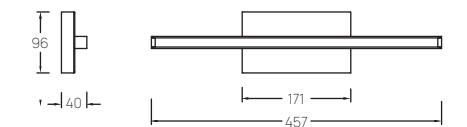

RWALM4



STREAMLINE INNOVATION. CONSTRUCT DAINTY RESIDENCES.

极简创意 塑雅致之所

JASMINE

主体材质 铝制灯身
 颜色 ● ●
 光源类型 SMD
 光源功率 8W/12W
 色温/显指 3000K, Ra90
 光源色容差 5 SDCM
 光源寿命 >36000h-L70 /B10-Ta25°C(LM-80/TM-21)
 光束角 ≥100°
 调光控制 ON-OFF



订购模型请详见339页



360°均匀发光 出光柔和

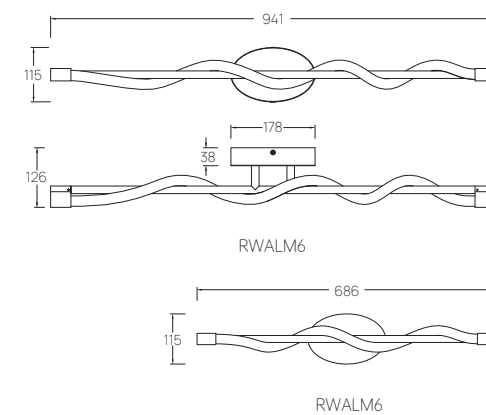



THE PERFECT COMPLEMENT TO ANY
DISPLAY PIECE. PROVIDING SUPERIOR COLOR RENDERING.
完美的衬托任何展示品 提供卓越的显色性

REED

主体材质 铝制灯身
颜色 ● ●
光源类型 SMD
光源功率 16W/18W/25W
色温/显指 3000K, Ra90
光源色容差 5 SDCM
光源寿命 >36000h-L70 /B10-Ta25°C(LM-80/TM-21)
光束角 >100°
调光控制 ON-OFF



订购模型请详见339页

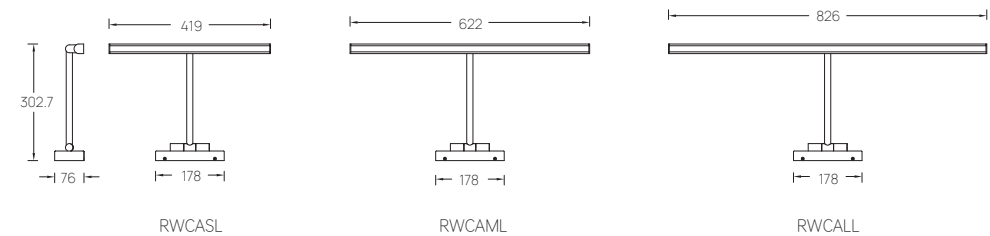



SLIM FINE ART LIGHT THAT HIGHLIGHTS FINE ART.
纤薄的美术灯 突出精美的艺术品

HUDSON

主体材质 铝制灯身
颜色 ● ●
光源类型 SMD
光源功率 12W/16W/22W
色温/显指 3000K, Ra90
光源色容差 5 SDCM
光源寿命 >36000h-L70 /B10-To25°C(LM-80/TM-21)
光束角 ≥100°
调光控制 ON-OFF



订购模型请详见340页

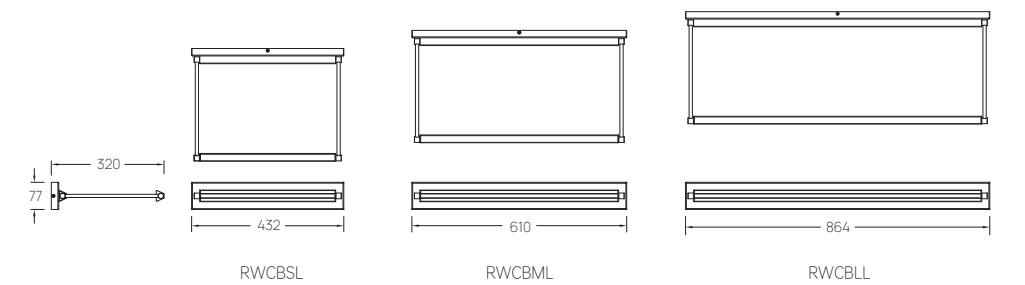



有边

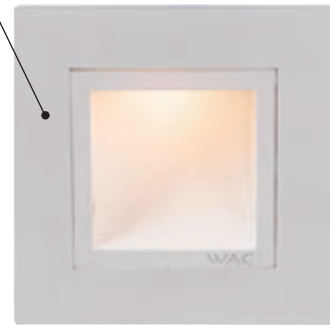

无边



RW211

主体材质 钣金安装板; PC 光学腔
 颜色 ○
 光源类型 SMD
 光源功率 1W Max
 色温/显指 2700K/3000K, Ra90
 光源色容差 5 SDCM
 光源寿命 >36000h-L70 / B10-Ta25°C(LM-80 / TM-21)
 光束角 >100°
 调光控制 ON-OFF



订购模型请详见340页

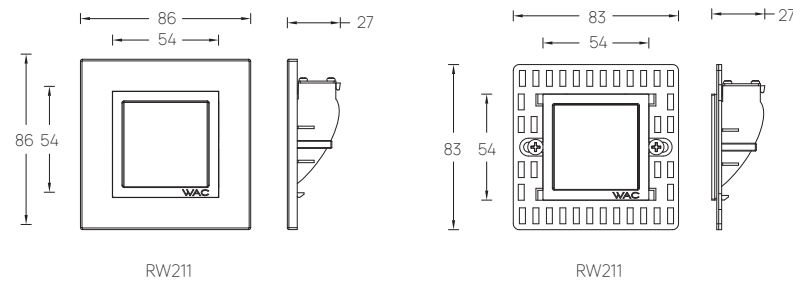

RW202

主体材质 铝压铸灯体
 颜色 ● ○ ● ● ● ●
 光源类型 SMD
 光源功率 1W Max
 色温/显指 3000K, Ra90
 光源色容差 5 SDCM
 光源寿命 >36000h-L70 / B10-Ta25°C(LM-80 / TM-21)
 光束角 >100°
 调光控制 ON-OFF



订购模型请详见340页

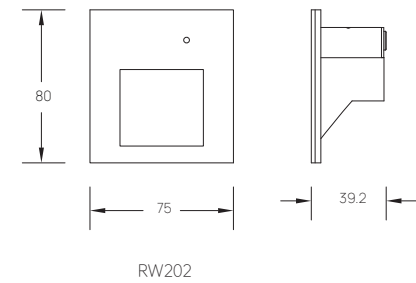

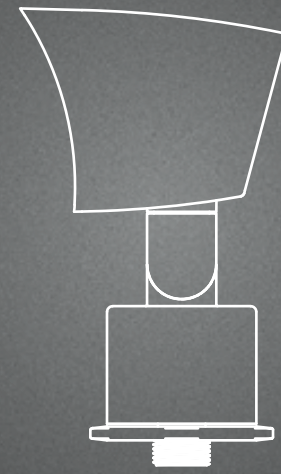

LANDSCAPE 户外景观灯

209-316P

IT HAS A SIMPLE SHAPE AND USES EFFECTIVE HEAT DISSIPATION
TO EXTEND THE LIFE OF LED LAMPS
LOW PROFILE DESIGN AND HIGH PERFORMANCE OPTICS STAND OUT FROM THE ENVIRONMENT

拥有简洁的外形 利用有效散热
延长 LED 灯具寿命
低调的轮廓设计与高性能的光学表现更能突显环境



LANDSCAPE 泛光灯

211-222P



WALL WASH 全彩洗墙

主体材质 整体铝合金材质
 颜色 ●
 光源类型 COB
 光源功率 0.5W-14.5W
 光源光通量 430lm@14.5W
 色温/显指 COLOUR CHANGE(全彩), Ra95
 光源色容差 5 SDCM
 光源寿命 >36000h-L70 /B10-Ta25°C(LM-80/TM-21)
 光束角 15°-50°X80°
 调光控制 蓝牙控制 (IOS应用程序)



订购模型请详见341页



蓝牙控制
 (IOS应用程序) 

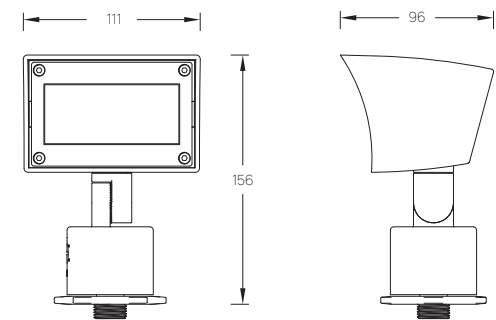

U5021



LOW PROFILE LINEAR

主体材质 整体铝合金材质
 颜色 ●
 光源类型 SMD
 光源功率 6W
 光源光通量 190lm/6W
 色温/显指 2700K/5000K, Ra85
 光源色容差 3 SDCM
 光源寿命 >36000h-L70 /B10-Ta25°C(LM-80/TM-21)
 光束角 80°-110°
 调光控制 ON-OFF



订购模型请详见341页

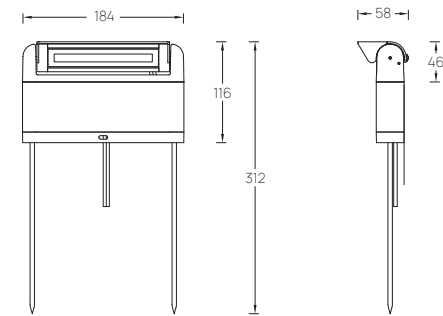

U6401



INTERBEAM 3W/6W 可变焦

主体材质 整体铝合金材质
 颜色 ●●
 光源类型 COB
 光源功率 3W/6W
 光源光通量 245lm@3W/475lm@6W
 色温/显指 2700K/3000K, Ra85
 光源色容差 3 SDCM
 光源寿命 >36000h-L70 /B10-Ta25°C(LM-80/TM-21)
 光束角 20°/35°/60°三档旋钮可调节
 调光控制 ON-OFF



订购模型请详见341页

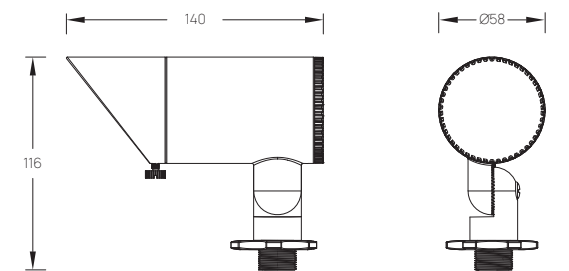

U5311/U5411



MINI WALL WASH 洗墙

主体材质 整体铝合金材质
 颜色 ●●●●
 光源类型 COB
 光源功率 1W-8W旋钮可调节
 光源光通量 80lm-420lm@1W-8W
 色温/显指 2700K/3000K旋钮可调节, Ra85
 光源色容差 3 SDCM
 光源寿命 >36000h-L70 /B10-Ta25°C(LM-80/TM-21)
 光束角 70°X95°
 调光控制 ON-OFF



订购模型请详见342页

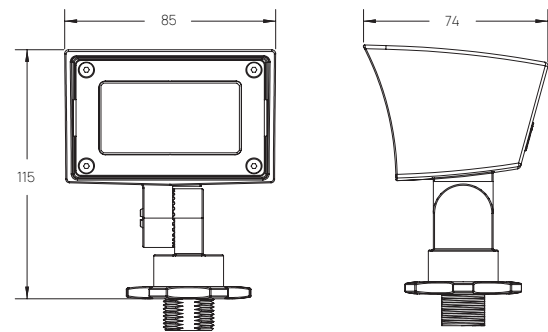

U5121





WALL WASH 洗墙

主体材质 整体铝合金材质
 颜色 ● ● ●
 光源类型 COB
 光源功率 1W-18W旋钮可调节
 光源光通量 190-980lm@1W-18W
 色温/显指 2700K/3000K, Ra85
 光源色容差 3 SDCM
 光源寿命 >36000h-L70 /B10-Ta25°C(LM-80/TM-21)
 光束角 15°-50°X80°可调节
 调光控制 ON-OFF



订购模型请详见342页

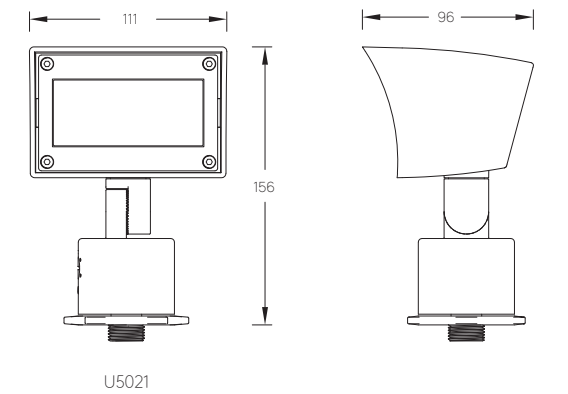

USING THE LATEST LED MODULES
GOOD LIGHT CONSISTENCY
WITH BEAM ANGLE ADJUSTMENT AND BRIGHTNESS ADJUSTMENT FUNCTIONS

使用最新的 LED 模块
出光一致性佳
具有光束角调节及亮度调节功能

LANDSCAPE 埋地灯

223-238P





蓝牙控制
(IOS 应用程序)

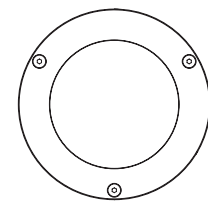

U5031

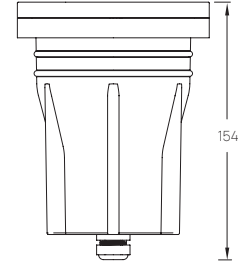

FUGO 3" 全彩 圆形

主体材质 整体铝合金材质
颜色 ●
光源类型 COB
光源功率 0.5W-14.5W
光源光通量 250lm@14.5W
色温/显指 COLOUR CHANGE (全彩), Ra85
光源色容差 5 SDCM
光源寿命 >36000h-L70 /B10-Ta25°C(LM-80/TM-21)
光束角 15°-60°
调光控制 蓝牙控制 (IOS 应用程序)



订购模型请详见342页

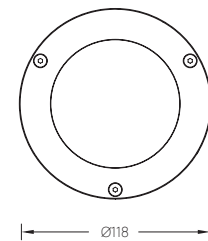

U5031

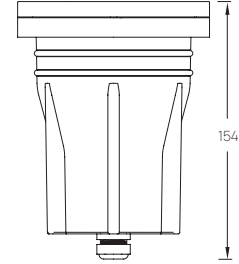

FUGO 3" 圆形

主体材质 整体铝合金材质
颜色 ● ●
光源类型 COB
光源功率 2W-12W旋钮可调节
光源光通量 70lm-505lm@2W-12W
色温/显指 2700K/3000K, Ra85
光源色容差 3 SDCM
光源寿命 >36000h-L70 /B10-Ta25°C(LM-80/TM-21)
光束角 20°-60° 旋钮可调节
调光控制 ON-OFF



订购模型请详见342页

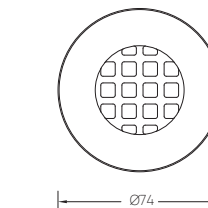

U2511

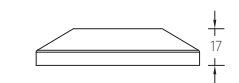

FUGO 2" 圆形超薄 格栅出光

主体材质 整体不锈钢材质
颜色 ● ●
光源类型 SMD
光源功率 2.8W
光源光通量 60lm@2.8W
色温/显指 2700K/3000K, Ra85
光源色容差 3 SDCM
光源寿命 50000h-L70 /B10-Ta25°C(LM-80/TM-21)
光束角 90°
调光控制 ON-OFF



订购模型请详见343页



FUGO 2" 3W/4W 圆形(超薄) 单侧出光

- 主体材质 整体不锈钢材质
- 颜色 ● ●
- 光源类型 SMD
- 光源功率 2.8W/4.1W
- 光源光通量 7lm@2.8W/5lm@4.1W
- 色温/显指 2700K/3000K, Ra85
- 光源色容差 3 SDCM
- 光源寿命 >50000h-L70 /B10-Ta25°C(LM-80/TM-21)
- 光束角 110°/≥100°
- 调光控制 ON-OFF



订购模型请详见343页

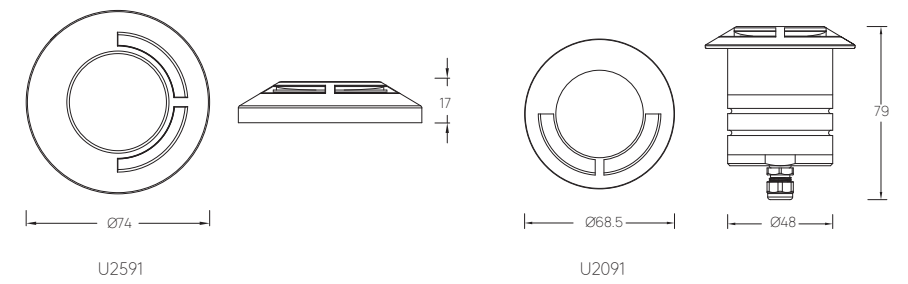



FUGO 2" 3W/4W 圆形(超薄) 双侧出光

主体材质 整体不锈钢材质
 颜色 ● ●
 光源类型 SMD
 光源功率 2.8W/4.1W
 光源光通量 5lm@2.8W/5lm@4.1W
 色温/显指 2700K/3000K, Ra85
 光源色容差 3 SDCM
 光源寿命 >50000h-L70 /B10-To25°C(LM-80/TM-21)
 光束角 180°/≥100°
 调光控制 ON-OFF



订购模型请详见343-344页

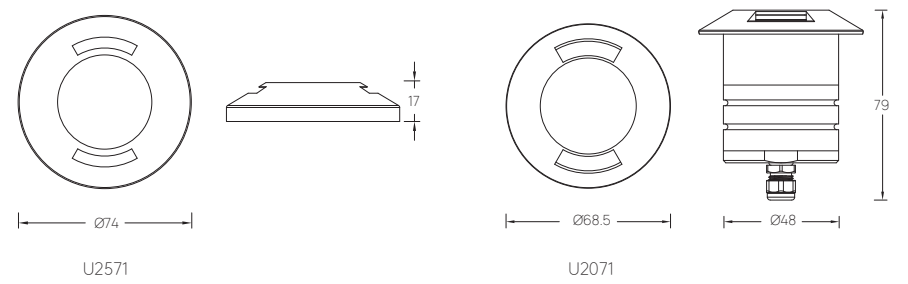

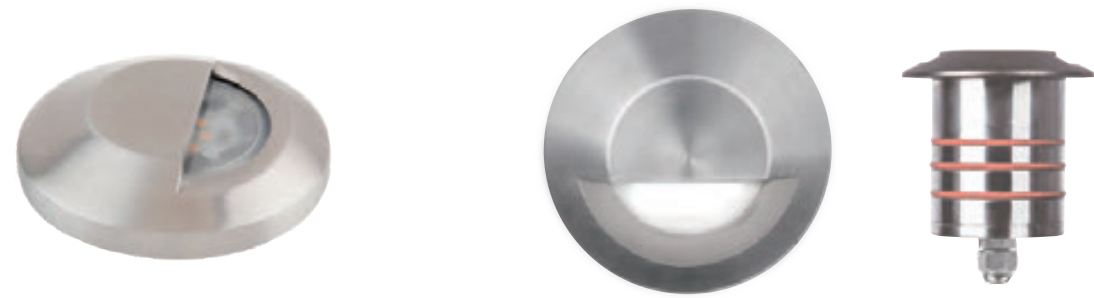

FUGO 2" 3W/4W 圆形(超薄) 单侧出光

主体材质 整体不锈钢材质
 颜色 ● ●
 光源类型 SMD
 光源功率 2.8W/4.1W
 光源光通量 50lm@2.8W/50lm@4.1W
 色温/显指 2700K/3000K, Ra85
 光源色容差 3 SDCM
 光源寿命 >50000h-L70 /B10-Ta25°C(LM-80/TM-21)
 光束角 90°/≥100°
 调光控制 ON-OFF



订购模型请详见344页

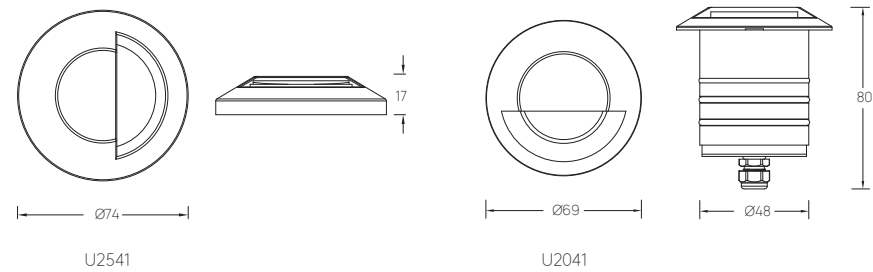



FUGO 2" 3W/4W 圆形(超薄) 四侧出光

主体材质 整体不锈钢材质
 颜色 ● ●
 光源类型 SMD
 光源功率 2.8W/4.1W
 光源光通量 4.5lm@2.8W/6lm@4.1W
 色温/显指 2700K/3000K, Ra85
 光源色容差 3 SDCM
 光源寿命 >50000h-L70 /B10-Ta25°C(LM-80/TM-21)
 光束角 180°/≥100°
 调光控制 ON-OFF



订购模型请详见344-345页

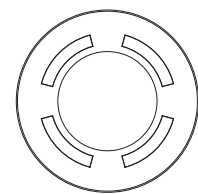

Ø74

U2501

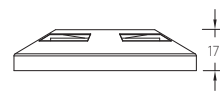

17

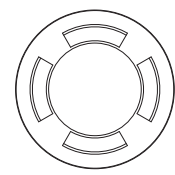

Ø68.5

U2101

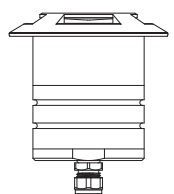

79

Ø48



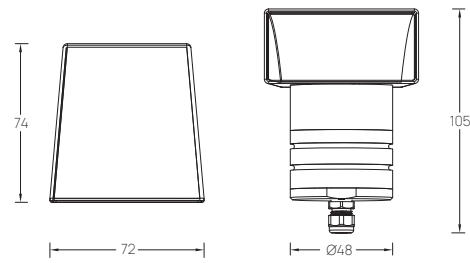

U2081

FUGO 2" 单侧面出光

主体材质 整体不锈钢材质
 颜色 ● ●
 光源类型 SMD
 光源功率 4.1W
 光源光通量 35lm@4.1W
 色温/显指 2700K/3000K, Ra85
 光源色容差 3 SDCM
 光源寿命 >50000h-L70 /B10-Ta25°C(LM-80/TM-21)
 光束角 >100°
 调光控制 ON-OFF



订购模型请详见345页

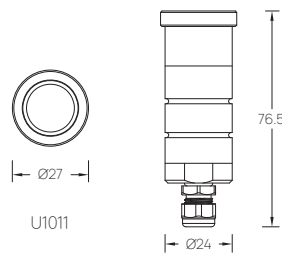

U1011

FUGO 1" 窄边框

主体材质 整体不锈钢材质
 颜色 ● ●
 光源类型 SMD
 光源功率 1.9W
 光源光通量 80lm@1.9W
 色温/显指 2700K/3000K, Ra85
 光源色容差 3 SDCM
 光源寿命 >50000h-L70 /B10-Ta25°C(LM-80/TM-21)
 光束角 50°
 调光控制 ON-OFF



订购模型请详见345页

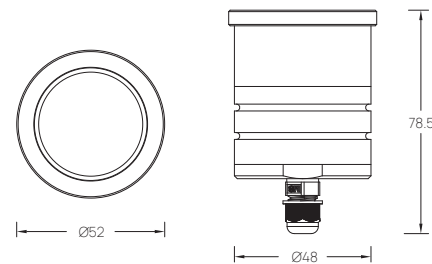

U2011

FUGO 2" 窄边框

主体材质 整体不锈钢材质
 颜色 ● ●
 光源类型 SMD
 光源功率 4.1W/1.9W
 光源光通量 170lm@4.1W
 色温/显指 2700K/3000K, Ra85
 光源色容差 3 SDCM
 光源寿命 >50000h-L70 /B10-Ta25°C(LM-80/TM-21)
 光束角 25°
 调光控制 ON-OFF



订购模型请详见345页

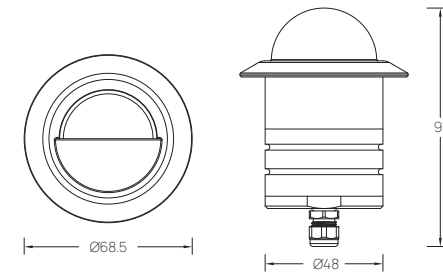

U2131

FUGO 2" 半圆形遮蔽出光

主体材质 整体不锈钢材质
 颜色 ● ●
 光源类型 SMD
 光源功率 5W
 光源光通量 135lm@5W
 色温/显指 2700K/3000K, Ra85
 光源色容差 3 SDCM
 光源寿命 >50000h-L70 /B10-Ta25°C(LM-80/TM-21)
 光束角 45°
 调光控制 ON-OFF



订购模型请详见346页

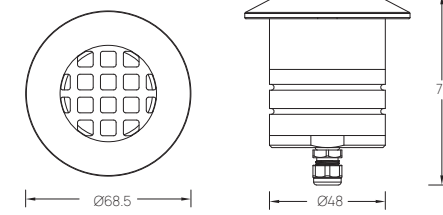

U2121

FUGO 2" 圆形 格栅出光

主体材质 整体不锈钢材质
 颜色 ● ●
 光源类型 SMD
 光源功率 5W
 光源光通量 85lm@5W
 色温/显指 2700K/3000K, Ra85
 光源色容差 3 SDCM
 光源寿命 >50000h-L70 /B10-Ta25°C(LM-80/TM-21)
 光束角 45°
 调光控制 ON-OFF



订购模型请详见346页

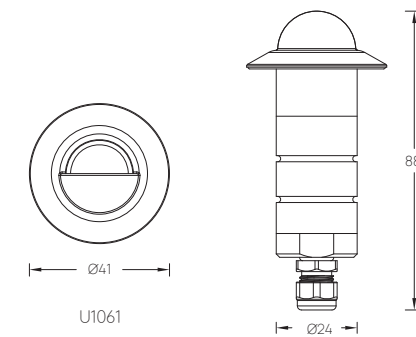

U1061

FUGO 1" 半圆形遮蔽出光

主体材质 整体不锈钢材质
 颜色 ● ●
 光源类型 SMD
 光源功率 1.9W
 光源光通量 68lm@1.9W
 色温/显指 2700K/3000K, Ra85
 光源色容差 3 SDCM
 光源寿命 >50000h-L70 /B10-Ta25°C(LM-80/TM-21)
 光束角 45°
 调光控制 ON-OFF



订购模型请详见346页



FUGO 1" 格栅遮蔽出光

主体材质 整体不锈钢材质
 颜色 ● ●
 光源类型 SMD
 光源功率 1.9W
 光源光通量 37lm@1.9W
 色温/显指 2700K/3000K, Ra85
 光源色容差 3 SDCM
 光源寿命 >50000h-L70 /B10-Ta25°C(LM-80/TM-21)
 光束角 45°
 调光控制 ON-OFF



订购模型请详见346页

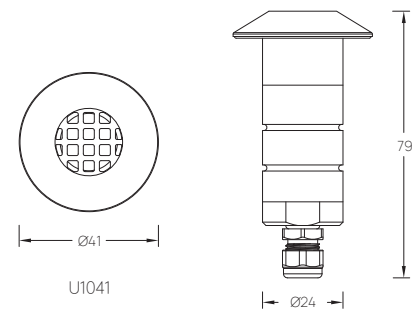

GEOMETRIC LIGHT BODY DESIGN
CREATES A UNIQUE SENSE OF BALANCE

几何灯体设计
创造出特有的平衡感



LANDSCAPE 壁灯

239-246P



ESTRELLA 双头出光

主体材质 整体铝合金材质
 颜色 ● ● ○
 光源类型 COB
 光源功率 1W-7.5W旋钮可调
 光源光通量 45lm-380lm@1W-7.5W
 色温/显指 2700K/3000K/4000K三档旋钮可调, Ra85
 光源色容差 3 SDCM
 光源寿命 >36000h-L70 /B10-Ta25°C(LM-80/TM-21)
 光束角 35°/45°/55°三档旋钮可调
 调光控制 ON-OFF



订购模型请详见347页

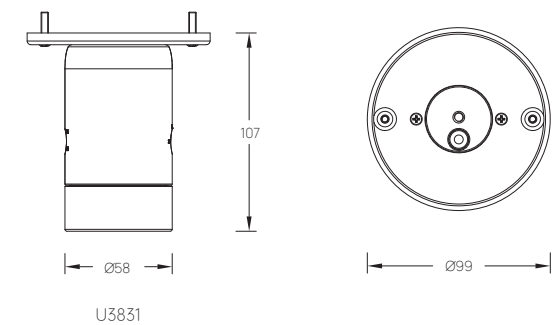



CYLINDER 双头出光

主体材质 整体铝合金材质
 颜色 ● ● ○
 光源类型 COB
 光源功率 7.5W
 光源光通量 325lm@7.5W (单头)
 色温/显指 2700K/3000K/4000K三档旋钮可调节, Ra85
 光源色容差 3 SDCM
 光源寿命 >36000h-L70 /B10-Ta25°C(LM-80/TM-21)
 光束角 35°/45°/55°三档旋钮可调节
 调光控制 ON-OFF



订购模型请详见347页

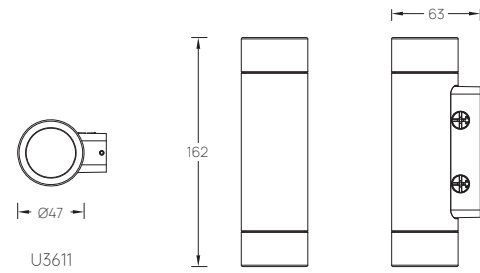

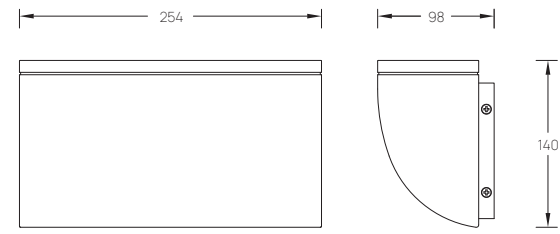

UWS-W20506

SCOOP 单头出光

主体材质 整体铝合金材质
 颜色 ● ● ● ● ● ●
 光源类型 COB
 光源功率 16W
 光源光通量 805lm@16W
 色温/显指 3000K, Ra90
 光源色容差 3 SDCM
 光源寿命 >36000h-L70 /B10-Ta25°C(LM-80/TM-21)
 光束角 >100°
 调光控制 ON-OFF(支持0-10V调光: 10%-100%)



订购模型请详见347页

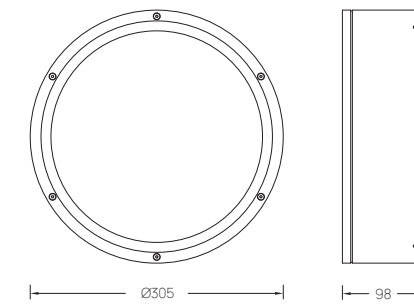

UFM-W2612

TUBE

主体材质 整体铝合金材质
 颜色 ● ● ● ● ● ●
 光源类型 COB
 光源功率 30W
 光源光通量 1740lm@30W
 色温/显指 3000K, Ra90
 光源色容差 3 SDCM
 光源寿命 >36000h-L70 /B10-Ta25°C(LM-80/TM-21)
 光束角 >100°
 调光控制 ON-OFF(支持0-10V调光: 10%-100%)

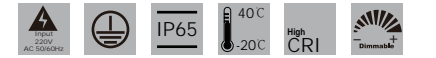

订购模型请详见348页

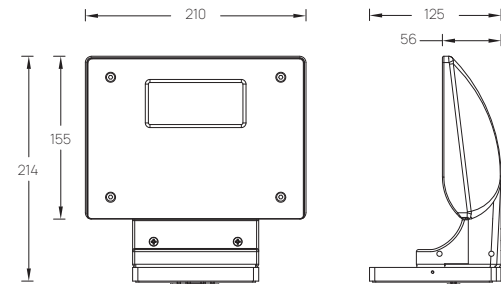

UWP-LED219-30/UWP-LED227-30

FIN 19W/27W

主体材质 整体铝合金材质
 颜色 ● ● ● ● ● ●
 光源类型 SMD
 光源功率 19W/27W
 光源光通量 1345lm@19W/2050lm@27W
 色温/显指 3000K, Ra85
 光源色容差 3 SDCM
 光源寿命 >36000h-L70 /B10-Ta25°C(LM-80/TM-21)
 光束角 >100°
 调光控制 ON-OFF(支持0-10V调光: 30%-100%)



订购模型请详见347-348页

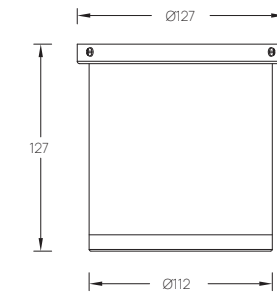

UFM-W2605

TUBE

主体材质 整体铝合金材质
 颜色 ● ● ● ● ● ●
 光源类型 COB
 光源功率 16W
 光源光通量 800lm@16W
 色温/显指 3000K, Ra90
 光源色容差 3 SDCM
 光源寿命 >36000h-L70 /B10-Ta25°C(LM-80/TM-21)
 光束角 >100°
 调光控制 ON-OFF(支持0-10V调光: 10%-100%)

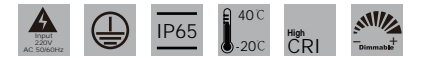

订购模型请详见349页

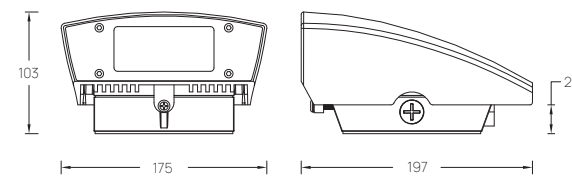

UWP-LED119-30/UWP-LED127-30/UWP-LED135-30

FIN 19W/27W/35W

主体材质 整体铝合金材质
 颜色 ● ● ● ● ● ●
 光源类型 COB
 光源功率 19W/27W/35W
 光源光通量 1390lm@19W/2075lm@27W/2750lm@35W
 色温/显指 3000K, Ra85
 光源色容差 3 SDCM
 光源寿命 >36000h-L70 /B10-Ta25°C(LM-80/TM-21)
 光束角 >100°
 调光控制 ON-OFF(支持0-10V调光: 30%-100%)



订购模型请详见348页

THE ULTIMATE MINIMALISM USED ALONE
OR A FEW TOGETHER ARE A GOOD CHOICE

极致的极简主义 单独使用
或者几个搭配在一起 都是不错的选择



LANDSCAPE 吸顶吊灯

247-252P



ESTRELLA

主体材质 整体铝合金材质
 颜色 ●●
 光源功率 1W-7.5W 旋钮可调节
 光束角 35°/45°/55° 三档旋钮可调节
 色温/显指 2700K/3000K/4000K, Ra85
 光源类型 COB
 光源光通量 45lm-380lm@1W-7.5W
 光源寿命 >36000h-L70 /B10-Ta25°C(LM-80/TM-21)
 光源色容差 3 SDCM
 调光控制 ON-OFF



订购模型请详见349页

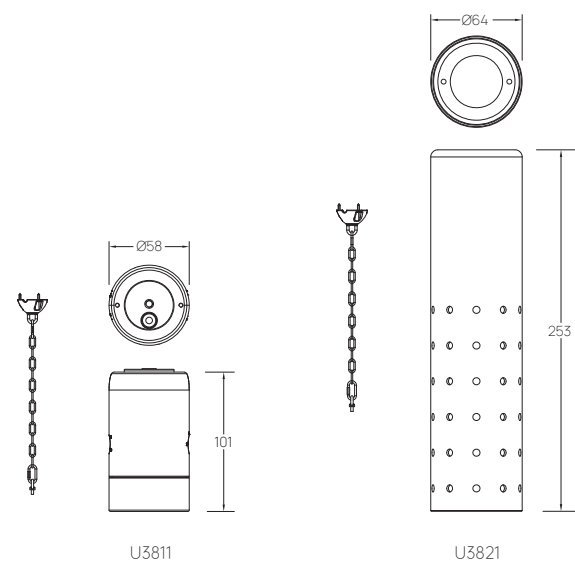



TUBE

主体材质 整体铝合金材质
 颜色 ● ● ○ ● ●
 光源类型 SMD
 光源功率 16W
 光源光通量 800lm@16W
 色温/显指 3000K, Ra90
 光源色容差 3 SDCM
 光源寿命 >36000h-L70 /B10-Ta25°C(LM-80/TM-21)
 光束角 >100°
 调光控制 ON-OFF(支持0-10V调光: 5%-100%)



订购模型请详见349页

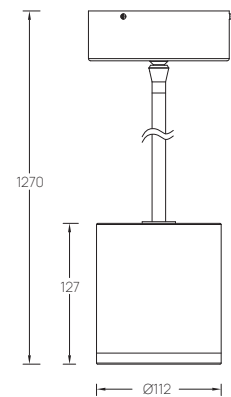

UPD-W2605

ICONIC SILHOUETTE VIBRANT
ATMOSPHERE OF THE SPACE

标志性的轮廓
活跃空间的氛围

LANDSCAPE 踢脚灯

253-260P





SRUFACE MOUNTER 8W/4W

- 主体材质 整体铝合金材质
- 颜色 ● ● ● ● ●
- 光源类型 SMD
- 光源功率 8W/4W
- 光源光通量 100lm@8W/55lm@4W
- 色温/显指 2700K/3000K, Ra85
- 光源色容差 3 SDCM
- 光源寿命 >36000h-L70 /B10-Ta25°C(LM-80/TM-21)
- 光束角 >100°
- 调光控制 ON-OFF



订购模型请详见350页

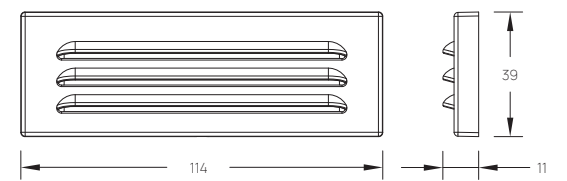

U4901

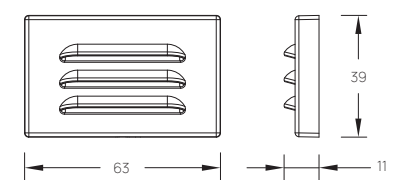

U4501

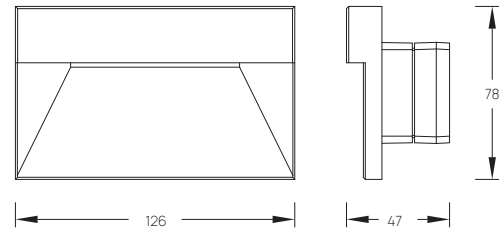

U4091

RECTANGLE

主体材质 整体铝合金材质
 颜色 ● ○ ●
 光源类型 SMD
 光源功率 2W
 光源光通量 3lm@2W
 色温/显指 2700K/3000K/Amber, Ra90
 光源色容差 3 SDCM
 光源寿命 >36000h-L70 /B10-Ta25°C(LM-80/TM-21)
 光束角 >100°
 调光控制 ON-OFF



订购模型请详见350页

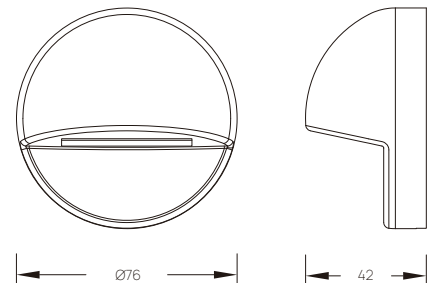

U3011

CIRCLE

主体材质 整体铝合金材质
 颜色 ● ● ● ●
 光源类型 SMD
 光源功率 2.8W
 光源光通量 60lm@2.8W
 色温/显指 2700K/3000K, Ra90
 光源色容差 3 SDCM
 光源寿命 >36000h-L70 /B10-Ta25°C(LM-80/TM-21)
 光束角 >100°
 调光控制 ON-OFF



订购模型请详见350页

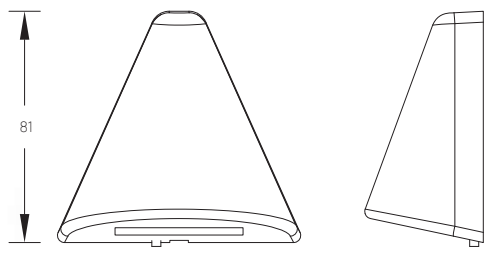

U3021

TRIANGLE

主体材质 整体铝合金材质
 颜色 ● ● ● ●
 光源类型 SMD
 光源功率 2.8W
 光源光通量 60lm@2.8W
 色温/显指 2700K/3000K, Ra90
 光源色容差 3 SDCM
 光源寿命 >36000h-L70 /B10-Ta25°C(LM-80/TM-21)
 光束角 >100°
 调光控制 ON-OFF



订购模型请详见351页

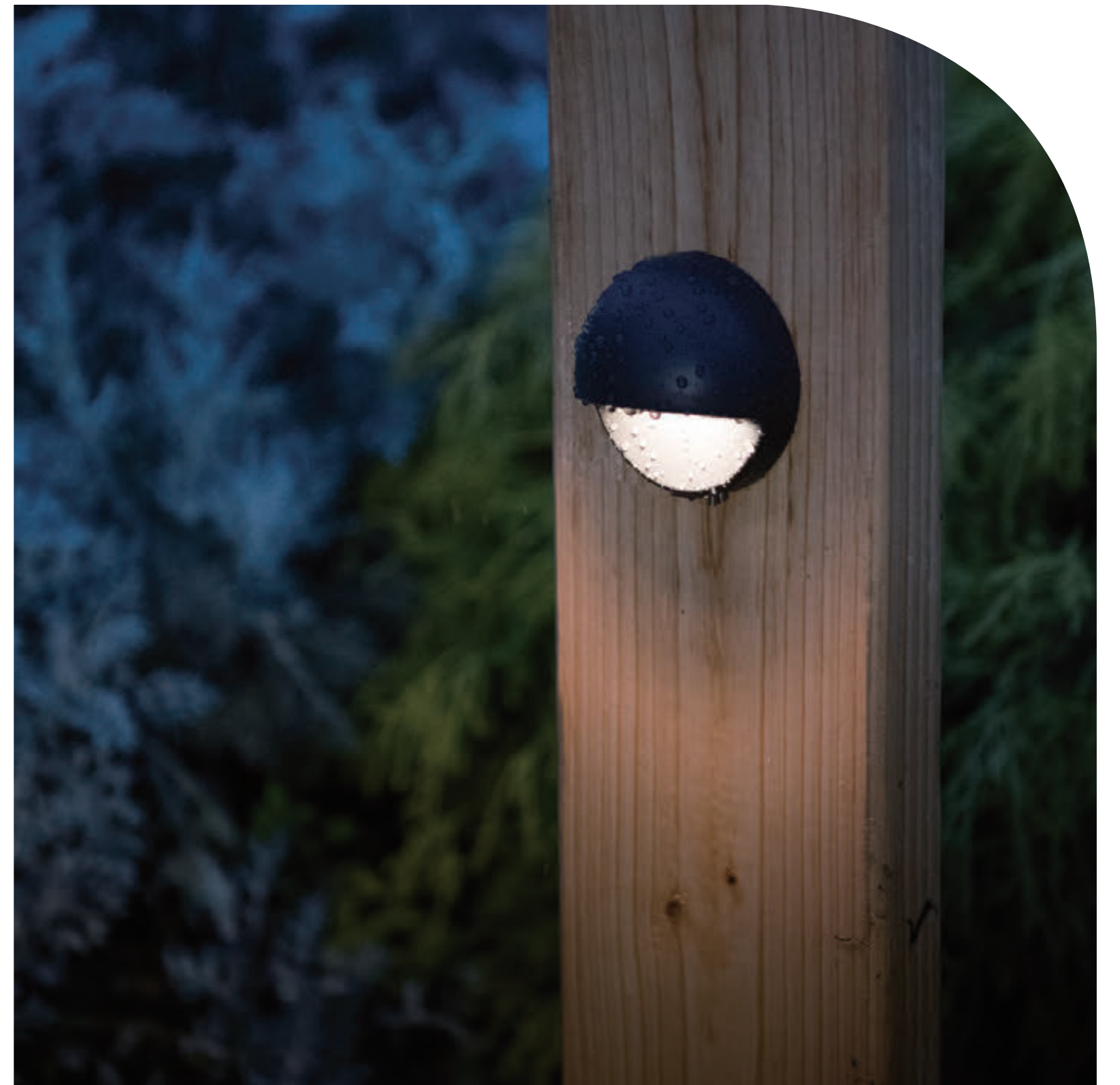

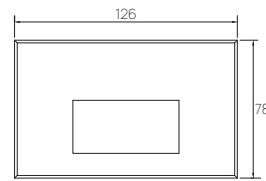

RW100

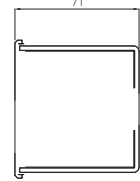

RW100

主体材质 铝压铸灯体
 颜色 ● ○ ● ●
 光源类型 SMD
 光源功率 5W Max
 光源光通量 2700K 180lm/3000K 190lm/4000K 200lm
 色温/显指 2700K/3000K/4000K, Ra80
 光源色容差 3 SDCM
 光源寿命 >40000h-L70 / B10-Ta25°C(LM-80 / TM-21)
 光束角 >100°
 调光方式 ON-OFF
 开孔尺寸 118x74mm



订购模型请详见351页

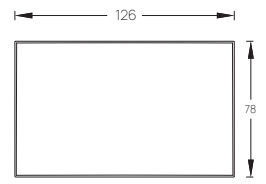

RW110

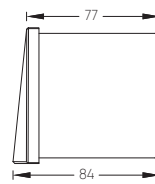

RW110

主体材质 铝压铸灯体
 颜色 ● ○ ● ●
 光源类型 SMD
 光源功率 5W
 光源光通量 3000K 190lm
 色温/显指 2700K/3000K/4000K, Ra80
 光源色容差 3 SDCM
 光源寿命 >40000h-L70 / B10-Ta25°C(LM-80 / TM-21)
 光学系统 雾面玻璃
 光束角 Directional
 调光控制 ON-OFF
 开孔尺寸 118x74mm



订购模型请详见351页

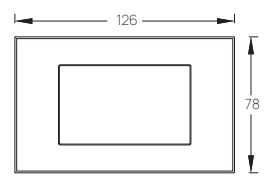

RW130

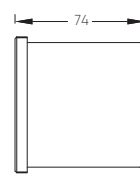

RW130

主体材质 铝压铸灯体
 颜色 ● ○ ● ●
 光源类型 SMD
 光源功率 4W Max
 光源光通量 3000K 190lm
 色温/显指 2700K/3000K/4000K, Ra80
 光源色容差 3 SDCM
 光源寿命 >40000h-L70 / B10-Ta25°C(LM-80 / TM-21)
 光学系统 乳白色玻璃
 光束角 Frosted
 调光控制 ON-OFF
 开孔尺寸 118x74mm



订购模型请详见352页

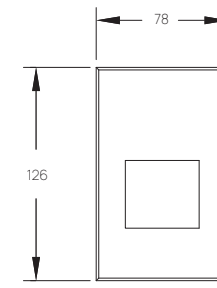

RW200

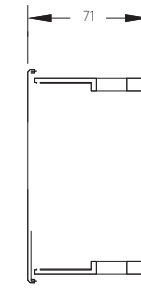

RW200

主体材质 铝压铸灯体
 颜色 ● ○ ● ●
 光源类型 SMD
 光源功率 5W Max
 光源光通量 2700K 180lm/3000K 190lm/4000K 200lm
 色温/显指 2700K/3000K/4000K, Ra80
 光源色容差 3 SDCM
 光源寿命 >40000h-L70 / B10-Ta25°C(LM-80 / TM-21)
 光束角 >100°
 调光控制 ON-OFF
 开孔尺寸 74x118mm



订购模型请详见352页

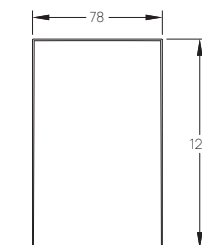

RW210

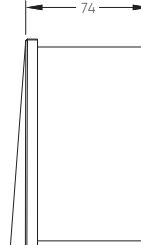

RW210

主体材质 铝压铸灯体
 颜色 ● ○ ● ●
 光源类型 SMD
 光源功率 5W Max
 光源光通量 3000K 190lm
 色温/显指 2700K/3000K/4000K, Ra80
 光源色容差 3 SDCM
 光源寿命 >40000h-L70 / B10-Ta25°C(LM-80 / TM-21)
 光学系统 雾面玻璃
 光束角 Directional
 调光控制 ON-OFF
 开孔尺寸 74x118mm



订购模型请详见352页



RW300

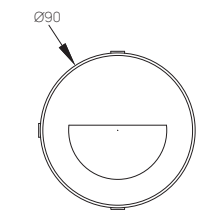

RW300

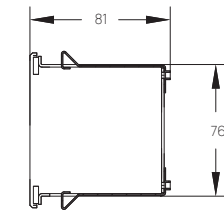

RW310

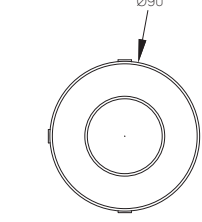

RW310

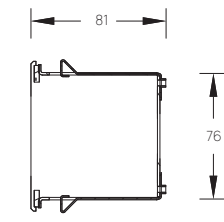

RW300 / RW310

主体材质 铝压铸灯体
 颜色 ● ○ ● ●
 光源类型 SMD
 光源功率 5W Max
 光源光通量 2700K 180lm/3000K 190lm/4000K 200lm
 色温/显指 2700K/3000K/4000K, Ra80
 光源色容差 3 SDCM
 光源寿命 >40000h-L70 / B10-Ta25°C(LM-80 / TM-21)
 光束角 >100°
 调光控制 ON-OFF
 开孔尺寸 Ø82mm



订购模型请详见351页

THE GENIE OF THE POOL
INDUSTRIAL QUALITY

泳池的精灵
工程级品质



LANDSCAPE 水下灯

261-264P



FUGO

主体材质 整体不锈钢材质
 颜色 ●
 光源类型 SMD
 光源功率 4.1W
 光源光通量 170lm@4.1W
 色温/显指 3000K, Ra85
 光源色容差 5 SDCM
 光源寿命 >50000h-L70 /B10-Ta25°C(LM-80/TM-21)
 光束角 25°
 调光控制 ON-OFF



订购模型请详见352页

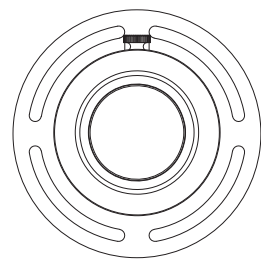

Ø102

U2031

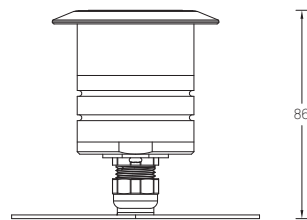

86

Ø48

Ø68.5



SIMPLE AND SOPHISTICATED AESTHETIC

简单而精致的美学

LANDSCAPE 线性系统

265-278P





INVISIBLE RGB

主体材质 柔性铜质 FPCB 板, 优质硅胶套管
 光源类型 SMD
 光源功率 1.5W/30cm
 色温/显指 RGB
 光源色容差 5 SDCM
 光源寿命 >36000h-L70 /B10-Ta25°C(LM-80/TM-21)
 光束角 115°
 调光控制 ON-OFF (支持DMX调光)



订购模型请详见353页

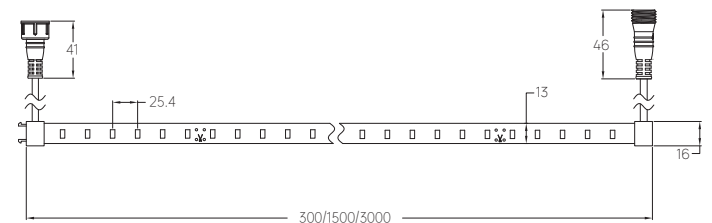

ULED-TCO



INVISIBLE

主体材质 柔性铜质 FPCB 板, 优质硅胶套管
 光源类型 SMD
 光源功率 1.2W/30cm
 光源光通量 100lm@1.2W
 色温/显指 2700K/3000K/4000K, Ra90
 光源色容差 3 SDCM
 光源寿命 >36000h-L70 /B10-Ta25°C(LM-80/TM-21)
 光束角 115°
 调光控制 ON-OFF



订购模型请详见353页

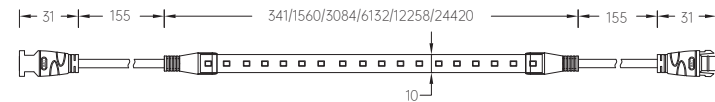

UT24-OD1



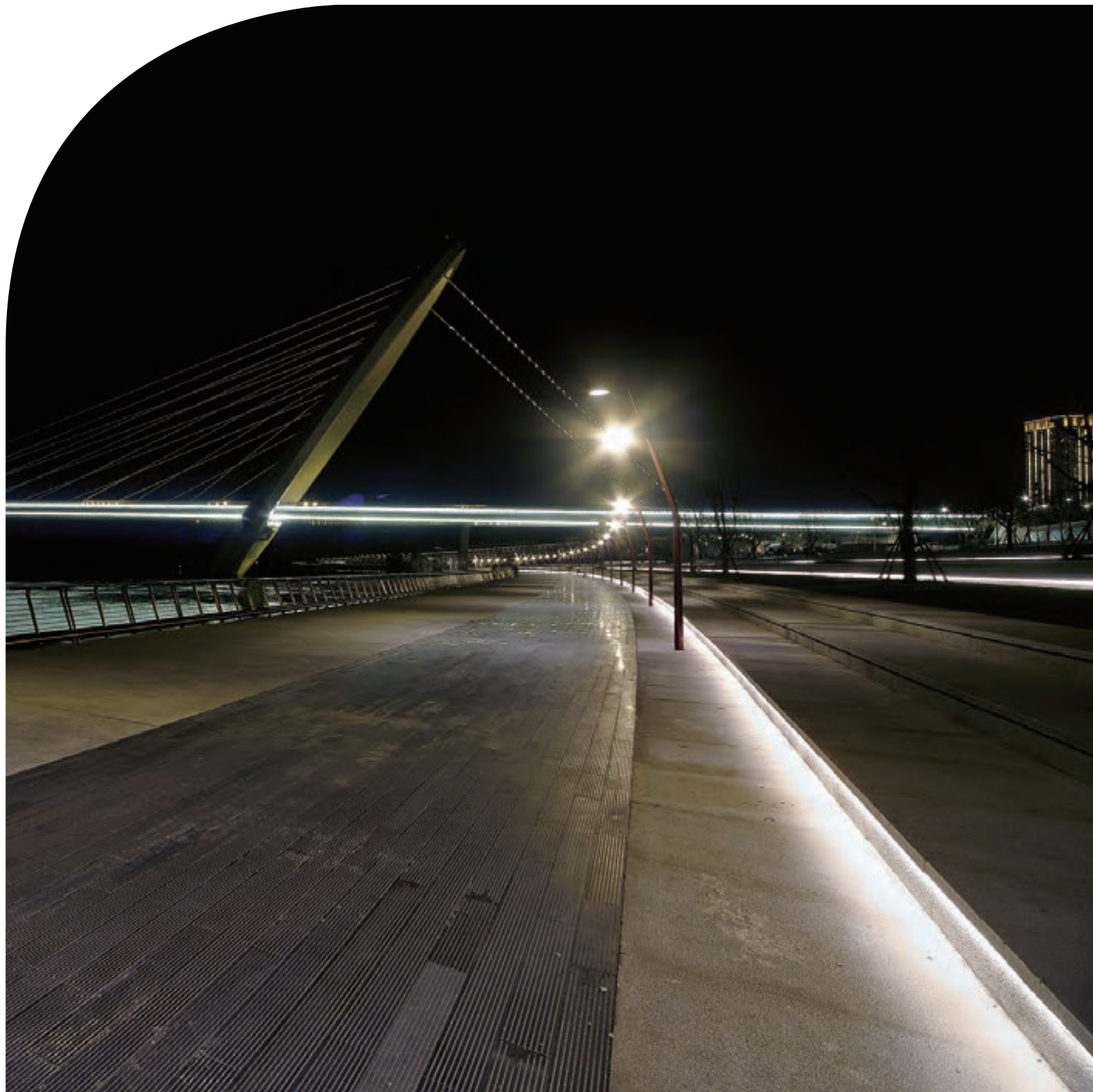

INVISILED PRO

主体材质 柔性铜质 FPCB 板, 优质硅胶套管
 光源类型 SMD
 光源功率 3.5W/30cm
 光源光通量 220lm@3.5W
 色温/显指 2700K/3000K/3500K, Ra90
 光源色容差 3 SDCM
 光源寿命 >36000h-L70 /B10-Ta25°C(LM-80/TM-21)
 光束角 110°
 调光控制 ON-OFF



订购模型请详见354页

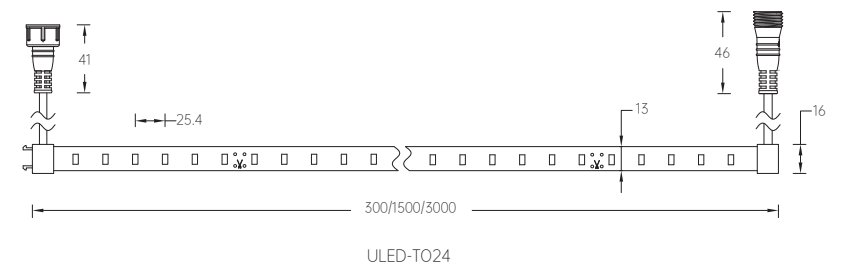



LANDSCAPE TAPE 20W/3米/10W/1.5米/2W/0.3米

主体材质 柔性铜质 FPCB 板, 优质硅胶套管
 光源类型 SMD
 光源功率 20W (300cm) / 10W (150cm) / 2W (30cm)
 光源光通量 1150lm@20W/575lm@10W/115lm@2W
 色温/显指 2700K/3000K, Ra85
 光源色容差 3 SDCM
 光源寿命 >36000h-L70 /B10-Ta25°C(LM-80/TM-21)
 光束角 110°
 调光控制 ON-OFF



订购模型请详见353页

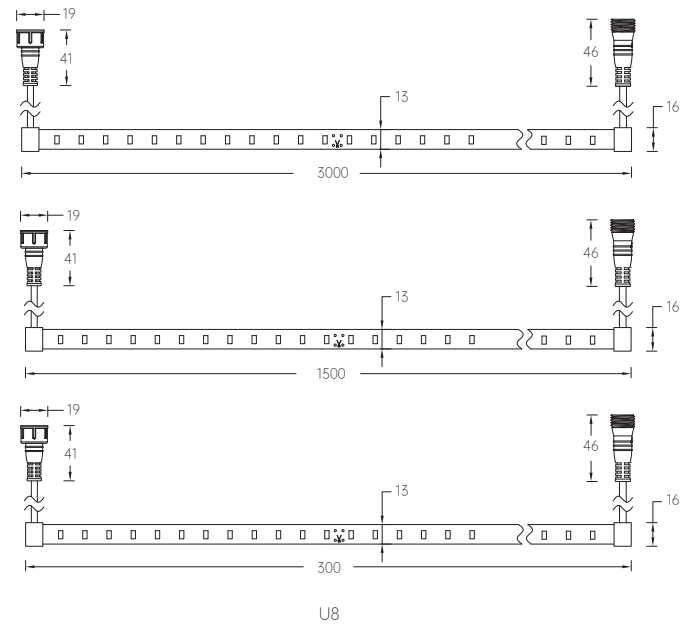



HARDSCAPE 8.5W/7W/4.5W

主体材质 整体铝合金材质
 颜色 ●●●●●
 光源类型 SMD
 光源功率 8.5W可旋钮调节亮暗/7W可旋钮调节亮暗/4.5W可旋钮调节亮暗
 光源光通量 350lm@8.5W/230lm@7W/110lm@4.5W
 色温/显指 2700K/3000K可旋钮调节, Ra85
 光源色容差 3 SDCM
 光源寿命 >36000h-L70 /B10-Ta25°C(LM-80/TM-21)
 光束角 110°
 调光控制 ON-OFF



订购模型请详见354页

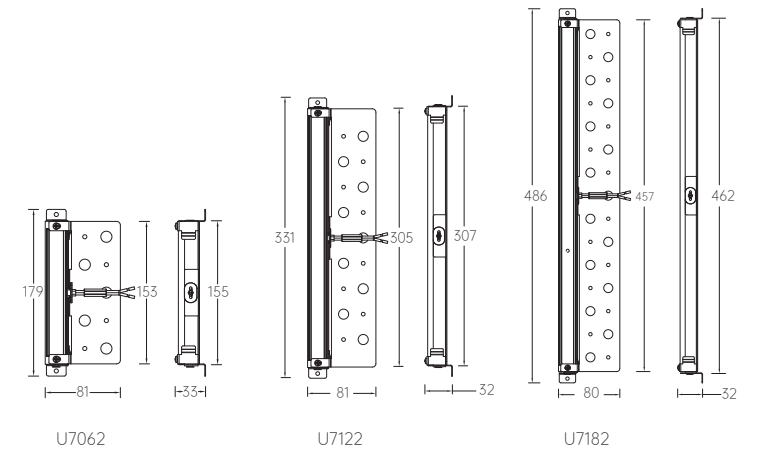



HARDSCAPE

主体材质 整体铝合金材质
 颜色 ● ● ● ● ●
 光源类型 SMD
 光源功率 1.5W可旋钮调节亮暗
 光源光通量 50lm@1.5W
 色温/显指 2700K/3000K, Ra85
 光源色容差 3 SDCM
 光源寿命 >36000h-L70 /B10-Ta25°C(LM-80/TM-21)
 光束角 ≥110°
 调光控制 ON-OFF



订购模型请详见354页

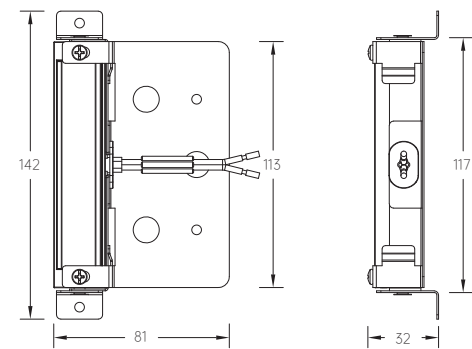

U7032

ILLUSTRATING CLASSIC BRAND WITH GLOBAL QUALITY

以全球品质演绎品牌经典

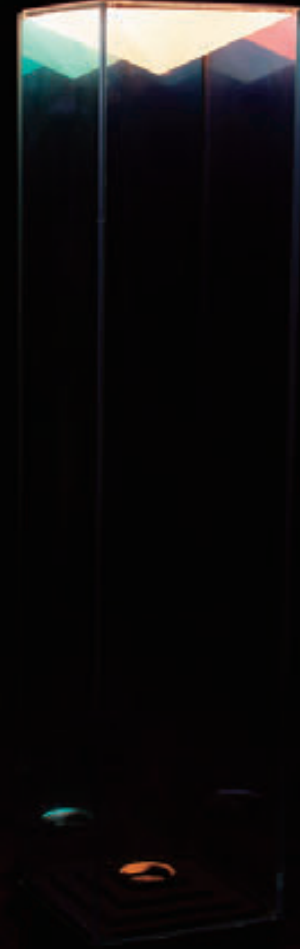

LANDSCAPE 矮柱灯

279-312P



MIRAGE 幻影

主体材质 铝制灯身+钢化玻璃
 颜色 ●
 光源类型 SMD
 光源功率 22W
 色温/显指 3000K, Ra90
 光源色容差 5 SDCM
 光源寿命 >36000h-L70 /B10-Ta25°C(LM-80/TM-21)
 光束角 >100°
 调光控制 ON-OFF



订购模型请详见355页

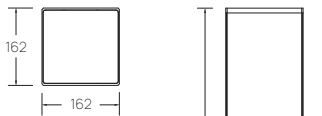

REBJ52



CANOPY

主体材质 铝合金压铸灯头，加强型铝合金挤灯柱
 颜色 ● ● ●
 光源类型 SMD
 光源功率 6W
 色温/显指 2700K/3000K/4000K, Ra90
 光源色容差 5 SDCM
 光源寿命 >50000h-L70 /B10-Ta25°C(LM-80/TM-21)
 光束角 ≥100°
 调光控制 ON-OFF



订购模型请详见355页

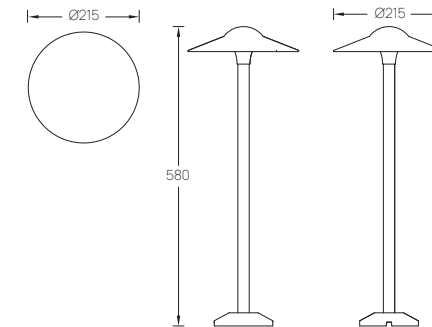

REBA31

CANOPY

主体材质 整体铝合金材质
 颜色 ● ● ●
 光源类型 SMD
 光源功率 6.5W
 光源光通量 225lm@6.5W
 色温/显指 2700K/3000K, Ra90
 光源色容差 3 SDCM
 光源寿命 >36000h-L70 /B10-Ta25°C(LM-80/TM-21)
 光束角 ≥100°
 调光控制 ON-OFF



订购模型请详见355页

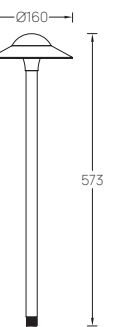

U6053



PARK

- 主体材质 加强型铝合金灯柱
- 颜色 ●●
- 光源类型 SMD
- 光源功率 10W
- 色温/显指 2700K/3000K/4000K, Ra90
- 光源色容差 5 SDCM
- 光源寿命 >50000h-L70 /B10-Ta25°C(LM-80/TM-21)
- 光束角 ≥100°
- 调光控制 ON-OFF



订购模型请详见355页

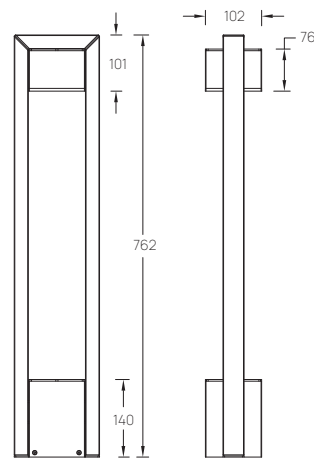

REBG42





CHAMBER

主体材质 加强型铝合金挤灯柱
 颜色 ● ●
 光源类型 SMD
 光源功率 10W
 色温/显指 2700K/3000K/4000K, Ra90
 光源色容差 5 SDCM
 光源寿命 >50000h-L70 /B10-Ta25°C(LM-80/TM-21)
 光束角 ≥100°
 调光控制 ON-OFF



订购模型请详见356页

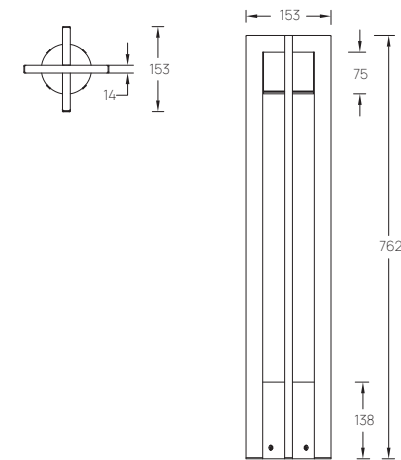

REBE41

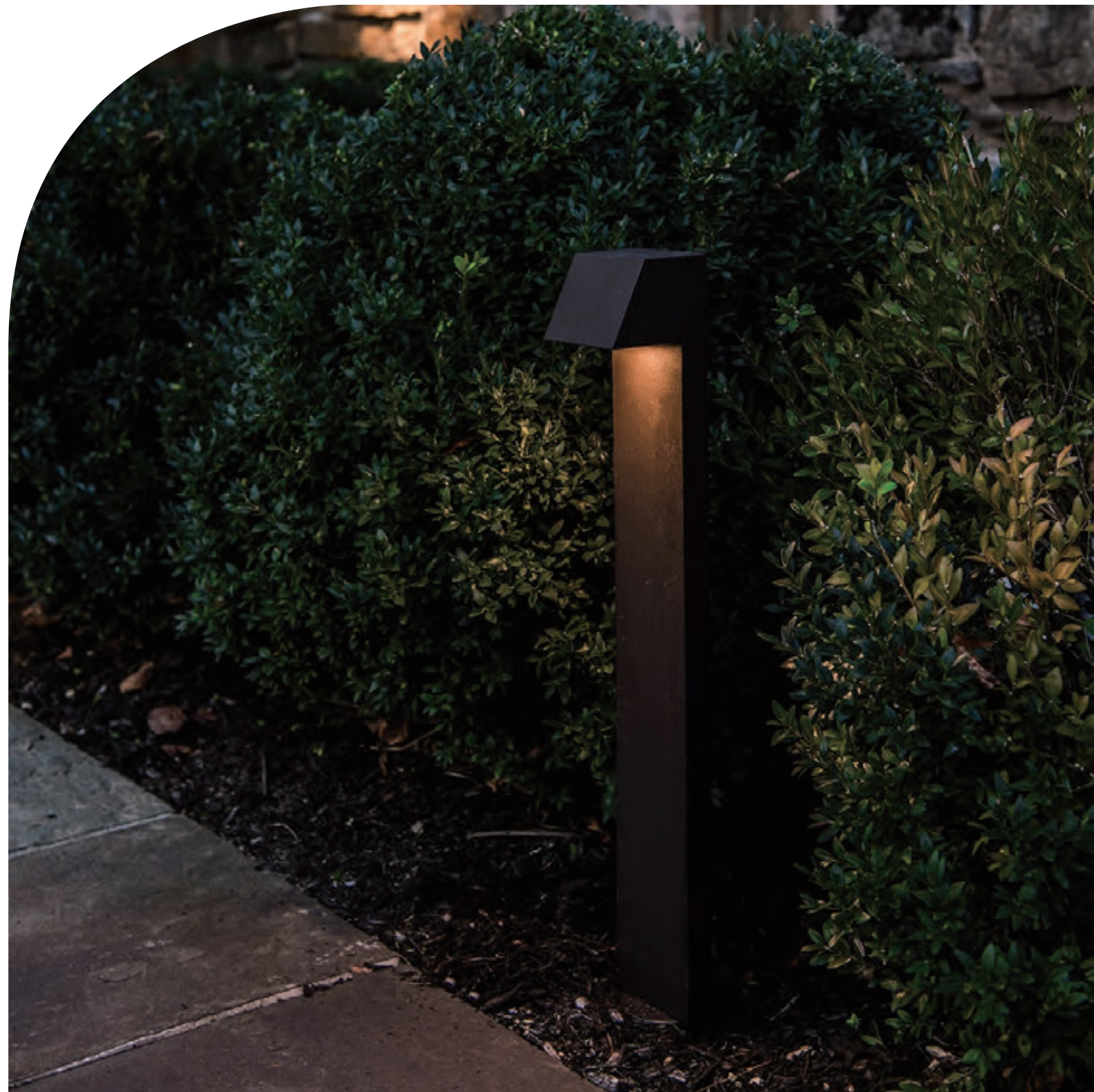

QUAD

主体材质 加强型铝合金灯柱
 颜色 ● ●
 光源类型 SMD
 光源功率 6W
 色温/显指 2700K/3000K/4000K, Ra90
 光源色容差 5 SDCM
 光源寿命 >50000h-L70 /B10-Ta25°C(LM-80/TM-21)
 光束角 >100°
 调光控制 ON-OFF



订购模型请详见356页

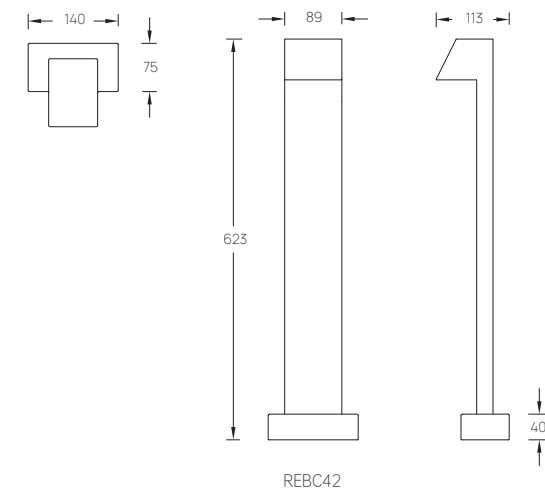



GATE

主体材质 加强型铝合金挤灯柱
 颜色 ● ●
 光源类型 SMD
 光源功率 6W
 色温/显指 2700K/3000K/4000K, Ra90
 光源色容差 5 SDCM
 光源寿命 >50000h-L70 /B10-Ta25°C(LM-80/TM-21)
 光束角 >100°
 调光控制 ON-OFF



订购模型请详见356页

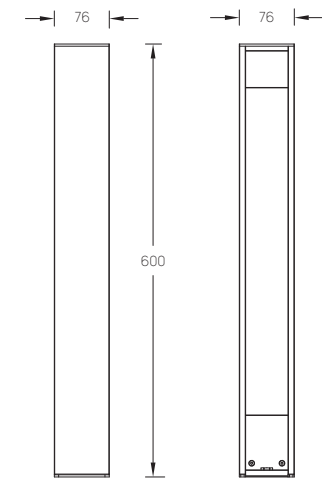

REBD42



MUSHROOM

主体材质 铝压铸灯头, 不锈钢安装固定底座及加强型铝挤灯柱
 颜色 ● ● ○
 光源类型 SMD
 光源功率 8W
 色温/显指 2700K/3000K/4000K, Ra85
 光源色容差 5 SDCM
 光源寿命 >50000h-L70 /B10-Ta25°C(LM-80/TM-21)
 光束角 >100°
 调光控制 ON-OFF



订购模型请详见357页

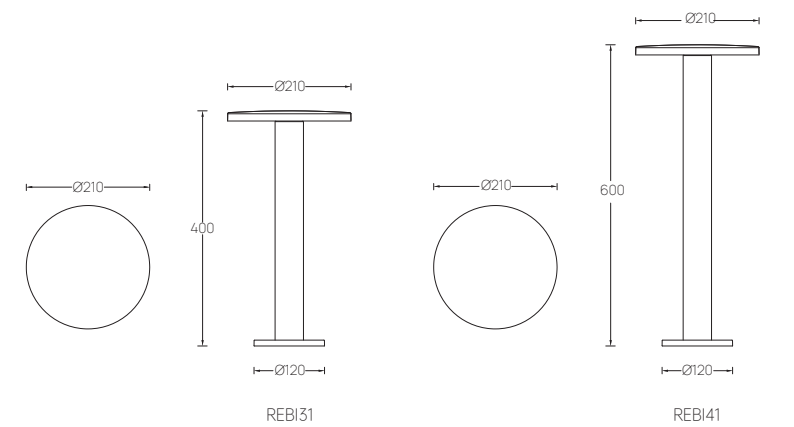



TOWER

主体材质 加强型铝合金灯柱
 颜色 ●●
 光源类型 SMD
 光源功率 10W
 色温/显指 2700K/3000K/4000K, Ra90
 光源色容差 5 SDCM
 光源寿命 >50000h-L70 /B10-Ta25°C(LM-80/TM-21)
 光束角 ≥100°
 调光控制 ON-OFF



订购模型请详见356页

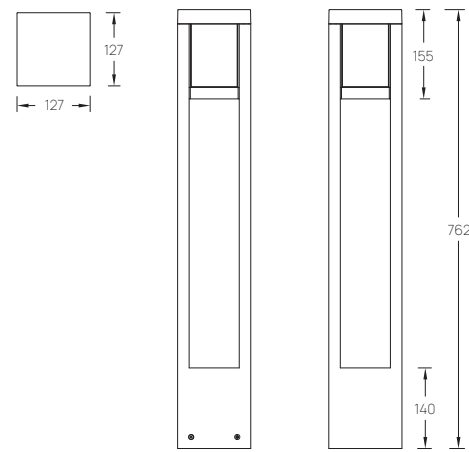

REBF42





LINEAR

主体材质 加强型铝合金灯柱
 颜色 ●●
 光源类型 SMD
 光源功率 6W
 色温/显指 2700K/3000K/4000K, Ra90
 光源色容差 5 SDCM
 光源寿命 >50000h-L70 /B10-Ta25°C(LM-80/TM-21)
 光束角 >=100°
 调光控制 ON-OFF



订购模型请详见357页

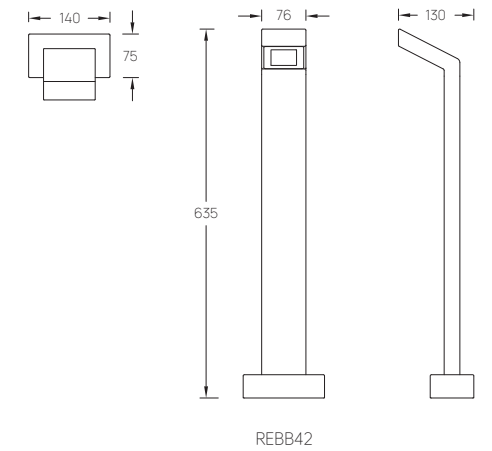

REBB42



SCOOP

主体材质 铝合金铸造一体成型
 颜色 ● ●
 光源类型 SMD
 光源功率 10W
 色温/显指 2700K/3000K/4000K, Ra90
 光源色容差 5 SDCM
 光源寿命 >50000h-L70 /B10-Ta25°C(LM-80/TM-21)
 光束角 >100°
 调光控制 ON-OFF



订购模型请详见357页

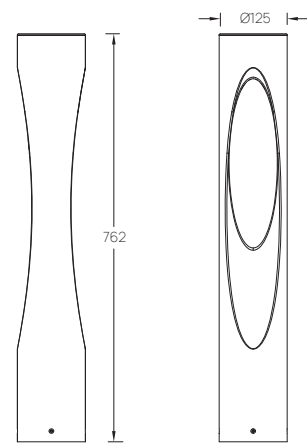

REBH41



MINI ACCENT 14W双头出光 7W单头出光

主体材质 整体铝合金材质
 颜色 ●●
 光源类型 COB
 光源功率 1W-7W 旋钮可调节
 光源光通量 45lm-365 lm@1W-7W
 色温/显指 2700K/3000K, Ra85
 光源色容差 3 SDCM
 光源寿命 >36000h-L70 /B10-Ta25°C(LM-80/TM-21)
 光束角 10°/25°/40°/50°四挡旋钮可调节
 调光控制 ON-OFF



订购模型请详见358页

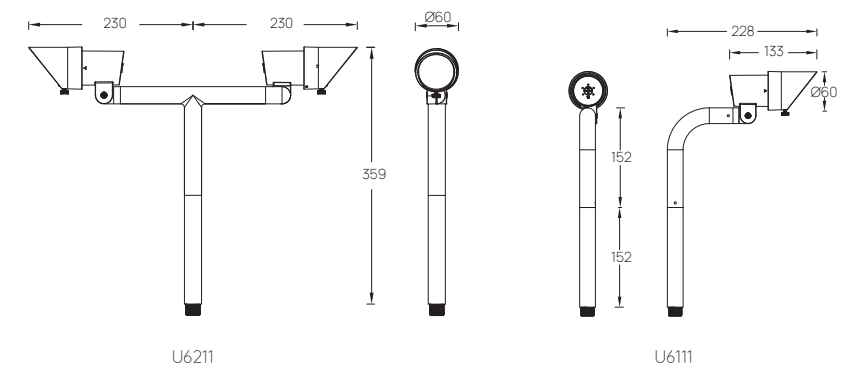

U6211

U6111



LEDGE

主体材质 整体铝合金材质
 颜色 ●●
 光源类型 SMD
 光源功率 3W
 光源光通量 105lm@3W
 色温/显指 2700K/3000K, Ra85
 光源色容差 3 SDCM
 光源寿命 >36000h-L70 /B10-Ta25°C(LM-80/TM-21)
 光束角 >100°
 调光控制 ON-OFF



订购模型请详见358页

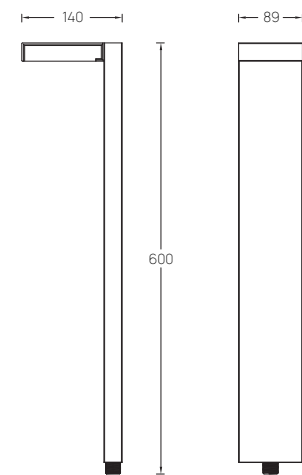

U6081



SLIDE

主体材质 整体铝合金材质
 颜色 ●
 光源类型 SMD
 光源功率 3W
 光源光通量 95lm@3W
 色温/显指 3000K, Ra85
 光源色容差 3 SDCM
 光源寿命 >36000h-L70 /B10-Ta25°C(LM-80/TM-21)
 光束角 ≥100°
 调光控制 ON-OFF



订购模型请详见358-359页

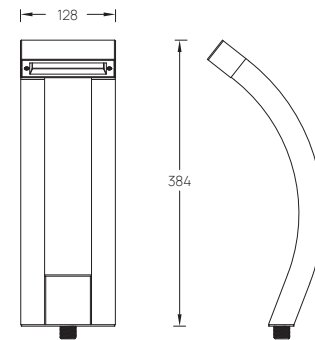

U6311

SLIDE

主体材质 整体铝合金材质
 颜色 ●
 光源类型 SMD
 光源功率 3W
 光源光通量 95lm@3W
 色温/显指 3000K, Ra85
 光源色容差 3 SDCM
 光源寿命 >36000h-L70 /B10-Ta25°C(LM-80/TM-21)
 光束角 ≥100°
 调光控制 ON-OFF



订购模型请详见358-359页

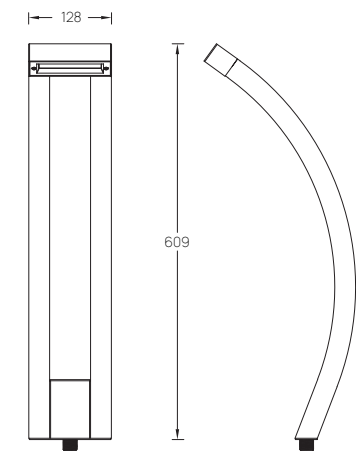

U6321



BALANCE 10W双头出光 6.5W单头出光

主体材质 整体铝合金材质
 颜色 ● ●
 光源类型 SMD
 光源功率 10W/6.5W
 光源光通量 375lm@10W/275lm@6.5W
 色温/显指 2700K/3000K, Ra90
 光源色容差 3 SDCM
 光源寿命 >36000h-L70 /B10-Ta25°C(LM-80/TM-21)
 光束角 ≥100°
 调光控制 ON-OFF



订购模型请详见359页

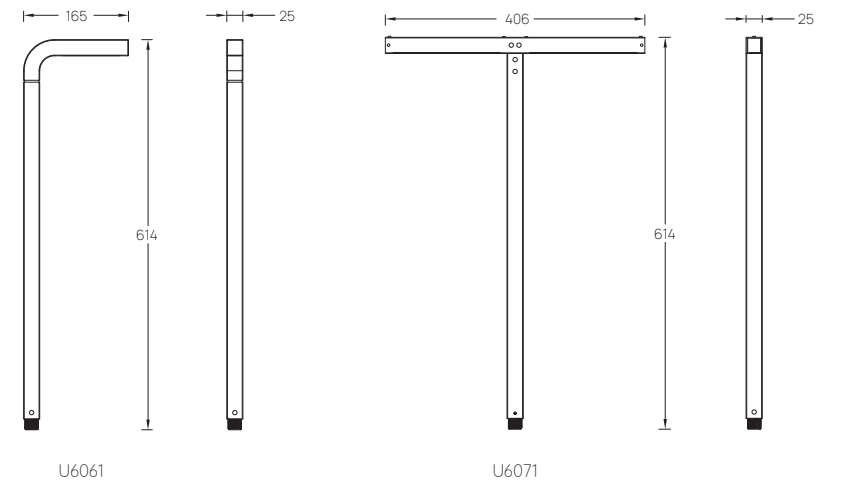

U6061

U6071



TIKI

主体材质 整体铝合金材质
 颜色 ●●/U6042 ●●●●/U6041
 光源类型 SMD
 光源功率 6.5W
 光源光通量 225lm@6.5W
 色温/显指 2700K/3000K, Ra90
 光源色容差 3 SDCM
 光源寿命 >36000h-L70 /B10-Ta25°C(LM-80/TM-21)
 光束角 ≥100°
 调光控制 ON-OFF



订购模型请详见359页

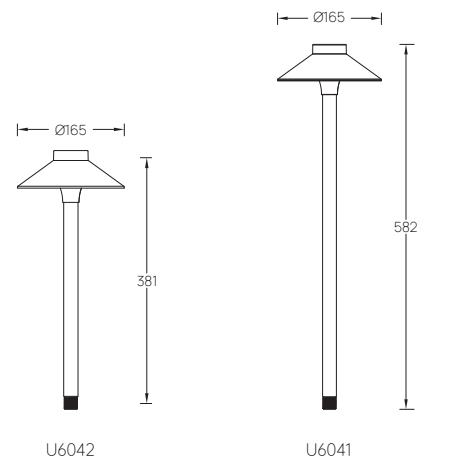



AREA

主体材质 整体铝合金材质
 颜色 ● ● ●
 光源类型 SMD
 光源功率 5.8W
 光源光通量 150lm@5.8W
 色温/显指 2700K/3000K, Ra90
 光源色容差 3 SDCM
 光源寿命 >36000h-L70 /B10-Ta25°C(LM-80/TM-21)
 光束角 ≥100°
 调光控制 ON-OFF



订购模型请详见360页

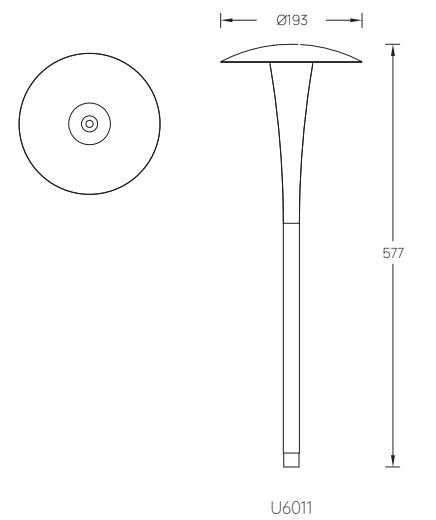

U6011

LANDSCAPE配件

景观灯配件

订购模型请详见367-368页

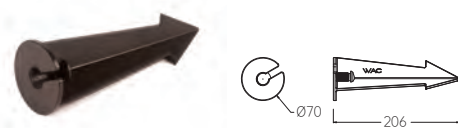

8寸注塑地插

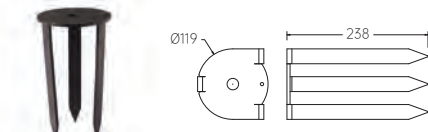

不锈钢景观灯安装地插



螺纹连接铝管

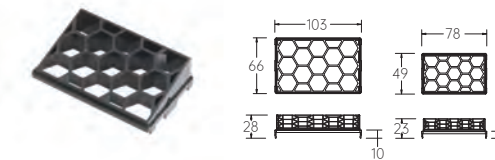

迷你景观洗墙灯系列蜂窝配件



铜质5寸出光罩



喷砂玻璃配件/喷砂钢化玻璃



螺纹L型铜接头



景观灯地面安装盖



水槽安装支架



景观灯树上安装盒

埋地类配件

订购模型请详见368-369页



螺纹L型铜接头

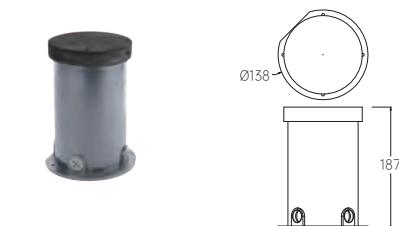

景观灯地面安装盖

光学配件

订购模型请详见369-370页



玻璃配件、蜂窝网



玻璃配件/玻璃配件Ø50×3 (平板)



铜质平口出光罩



蜂窝网

UT24-OD1配件

订购模型请详见370-372页



24V恒压电源AC120V-277V输入96W



Joiner灯带连接线



InvisiLED接引线 (室内电源)



InvisiLED电源连接线



InvisiLED灯带Y型3位连接件



防水端盖



防水硅胶



InvisiLED背装固定卡扣



单侧明装固定卡扣



InvisiLED灯带型材/灯带型材



双侧明装固定卡扣

ULED-TO24配件

订购模型请详见372-373页



24V恒压电源AC120V-277V输入96W



背装固定卡扣



单侧明装固定卡扣



双侧明装固定卡扣



灯带型材



Joiner灯带连接线



Y型3位连接线



X型4位连接线

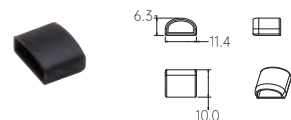

防水端盖

ULED-TCO配件

订购模型请详见373-375页

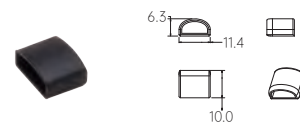

防水端盖



Y型4位连接件

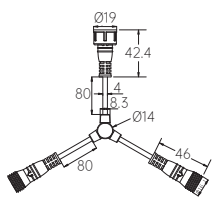

Joiner灯带连接线

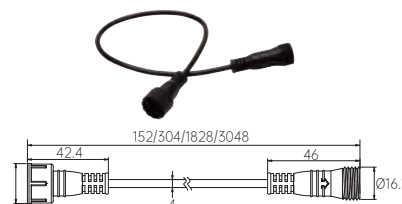

Joiner灯带连接线



RGB信号线 (控制器)



RGB DMX信号线



X型4位连接线



24V恒压电源AC120V-277V输入96W



RGB 24V恒压输入分控器



RGB 24V恒压输入主控器



RGB遥控器 (控制器)



灯带型材



单侧明装固定卡扣



双侧明装固定卡扣



背装固定卡扣

U8系列配件

订购模型请详见375-376页



Y型3位连接线



X型4位连接线



Joiner灯带连接线



灯带连接线

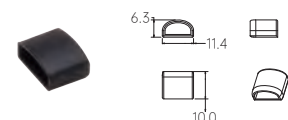

防水端盖



背装固定卡扣



单侧明装固定卡扣





双侧明装固定卡扣





灯带型材

订购模型 Order Model



DOWNLIGHT 筒灯 CHENXING 辰星

Model	Size	Trim	LED Power	Driver	Beam	CCT	Reflector	Finish
 RDAL 辰星 2寸下照筒灯	2 2"	1 Round Trim 2 Round Trimless	05 5W 07 7W	E On-Off D 0-10V Dimming	1 18° 2 28° 3 36°	27 2700K 30 3000K 35 3500K 40 4000K	B Black S Specular F Frosted C Champagne	WT White
			05 5W	N No Driver		CC 2700K-6500K 可变色温		
 RDAD 辰星 2寸调角筒灯	2 2"	1 Round Trim 2 Round Trimless	05 5W 07 7W	E On-Off D 0-10V Dimming	1 18° 2 28° 3 36°	27 2700K 30 3000K 35 3500K 40 4000K	B Black S Specular F Frosted C Champagne	WT White
			05 5W	N No Driver		CC 2700K-6500K 可变色温		

示例: RDAL21-05E-127SWT
*不含驱动版本: 5W@36V 150mA, 7W@36V 180mA;

Model	Size	Trim	LED Power	Driver	Beam	CCT	Reflector	Finish
 RDAL 辰星 2寸下照筒灯	2 2"	5 Rectangular Trim 6 Rectangular Trimless	05 5W 07 7W	E On-Off D 0-10V Dimming	1 18° 2 28° 3 36°	27 2700K 30 3000K 35 3500K 40 4000K	B Black S Specular F Frosted C Champagne	WT White
			05 5W	N No Driver		CC 2700K-6500K 可变色温		
 RDAD 辰星 2寸调角筒灯	2 2"	5 Rectangular Trim 6 Rectangular Trimless	05 5W 07 7W	E On-Off D 0-10V Dimming	1 18° 2 28° 3 36°	27 2700K 30 3000K 35 3500K 40 4000K	B Black S Specular F Frosted C Champagne	WT White
			05 5W	N No Driver		CC 2700K-6500K 可变色温		









示例: RDAL25-05E-127SWT
注: 不含驱动版本: 5W@36V 150mA, 7W@36V 180mA;

Model	Size	Trim	LED Power	Driver	Beam	CCT	Reflector	Finish
 RDAL 辰星 3寸下照筒灯	3 3"	1 Round Trim 2 Round Trimless	07 7W 10 10W	E On-Off D 0-10V Dimming	1 18° 2 28° 3 36°	27 2700K 30 3000K 35 3500K 40 4000K	B Black S Specular F Frosted C Champagne	WT White
			10 10W Max	N No Driver		CC 2700K-6500K 可变色温		
 RDAD 辰星 3寸调角筒灯	3 3"	1 Round Trim 2 Round Trimless	07 7W 10 10W	E On-Off D 0-10V Dimming	1 18° 2 28° 3 36°	27 2700K 30 3000K 35 3500K 40 4000K	B Black S Specular F Frosted C Champagne	WT White
			10 10W Max	N No Driver		CC 2700K-6500K 可变色温		











示例: RDAD31-07E-127SWT
注: 不含驱动版本: 7W@36V 180mA, 10W@36V 250mA;

Model	Size	Trim	LED Power	Driver	Beam	CCT	Reflector	Finish
 RDAL 辰星 3寸下照筒灯	3 3"	5 Rectangular Trim 6 Rectangular Trimless	07 7W 10 10W	E On-Off D 0-10V Dimming	1 18° 2 28° 3 36°	27 2700K 30 3000K 35 3500K 40 4000K	B Black S Specular F Frosted C Champagne	WT White
			10 10W Max	N No Driver		CC 2700K-6500K 可变色温		
 RDAD 辰星 3寸调角筒灯	3 3"	5 Rectangular Trim 6 Rectangular Trimless	07 7W 10 10W	E On-Off D 0-10V Dimming	1 18° 2 28° 3 36°	27 2700K 30 3000K 35 3500K 40 4000K	B Black S Specular F Frosted C Champagne	WT White
			10 10W Max	N No Driver		CC 2700K-6500K 可变色温		





示例: RDAD35-07E-127SWT
注: 不含驱动版本: 7W@36V 180mA, 10W@36V 250mA;

Model	Size	Trim	LED Power	Driver	Beam	CCT	Reflector	Finish
 RDAL 辰星 4 寸下照筒灯	4 4"	1 Round Trim	18 18W 22 22W	E On-Off D 0-10V Dimming	1 18° 2 28° 3 36°	27 2700K 30 3000K 35 3500K 40 4000K	B Black  S Specular  F Frosted  C Champagne 	WT White <input type="checkbox"/>
			18 18W	N No Driver		CC 2700K-6500K 可变色温		
 RDAD 辰星 4 寸调角筒灯	4 4"	1 Round Trim	18 18W 22 22W	E On-Off D 0-10V Dimming	1 18° 2 28° 3 36°	27 2700K 30 3000K 35 3500K 40 4000K	B Black  S Specular  F Frosted  C Champagne 	WT White <input type="checkbox"/>
			18 18W	N No Driver		CC 2700K-6500K 可变色温		











示例: RDAL41-18E-127SWT
注: 不含驱动版本 :18W @36V 500mA, 22W@36V 600mA;

Model	Size	Trim	LED Power	Driver	Beam	CCT	Reflector	Finish
 RDAL 辰星 4 寸下照筒灯	4 4"	5 Rectangular Trim	18 18W 22 22W	E On-Off D 0-10V Dimming	1 18° 2 28° 3 36°	27 2700K 30 3000K 35 3500K 40 4000K	B Black  S Specular  F Frosted  C Champagne 	WT White <input type="checkbox"/>
			18 18W	N No Driver		CC 2700K-6500K 可变色温		
 RDAD 辰星 4 寸调角筒灯	4 4"	5 Rectangular Trim	18 18W 22 22W	E On-Off D 0-10V Dimming	1 18° 2 28° 3 36°	27 2700K 30 3000K 35 3500K 40 4000K	B Black  S Specular  F Frosted  C Champagne 	WT White <input type="checkbox"/>
			18 18W	N No Driver		CC 2700K-6500K 可变色温		

示例: RDAL45-18E-127SWT
注: 不含驱动版本 :18W@36V 500mA, 22W@36V 600mA;

Model	Size	Trim	LED Power	Driver	Beam	CCT	Reflector	Finish
 RDAW 辰星 3 寸洗墙筒灯	3 3"	1 Round Trim	07 7W	E On-Off D 0-10V Dimming N No Driver	W Wall Washer	27 2700K 30 3000K 35 3500K 40 4000K	B Black  WT White <input type="checkbox"/>	WT White <input type="checkbox"/>
				N No Driver		CC 2700K-6500K 可变色温		
 RDAW 辰星 4 寸洗墙筒灯	4 4"	1 Round Trim	18 18W 22 22W	E On-Off D 0-10V Dimming	W Wall Washer	27 2700K 30 3000K 35 3500K 40 4000K	B Black  WT White <input type="checkbox"/>	WT White <input type="checkbox"/>
			18 18W	N No Driver		CC 2700K-6500K 可变色温		

示例: RDAW31-07E-W27BWT
注: 不含驱动版本 :7W@12V 700mA; 18W@36V 500mA, 22W@36V 600mA;

Model	Size	Trim	LED Power	Driver	Beam	CCT	Reflector	Finish
 RDAM 辰星 3 寸洗墙筒灯	3 3"	5 Rectangular Trim	207 2x7W 210 2x10W	E On-Off D 0-10V Dimming	1 18° 2 28° 3 36°	27 2700K 30 3000K 35 3500K 40 4000K	B Black  S Specular  F Frosted  C Champagne 	WT White <input type="checkbox"/>
			210 2x10W Max	N No Driver		CC 2700K-6500K 可变色温		
			210 2x10W Max	N No Driver				
 RDAM 辰星 3 寸洗墙筒灯	3 3"	5 Rectangular Trim	307 2x7W 310 2x10W	E On-Off D 0-10V Dimming	1 18° 2 28° 3 36°	27 2700K 30 3000K 35 3500K 40 4000K	B Black  S Specular  F Frosted  C Champagne 	WT White <input type="checkbox"/>
			310 3x10W Max	N No Driver		CC 2700K-6500K 可变色温		
			310 3x10W Max	N No Driver				

示例: RDAM35-207E-127SWT
注: : 单头 7W@36V 180mA, 10W@36V 250mA Max;

LA LÍNEA琳奈

Model	Size	Install	LED	Driver	Beam	CCT	Reflector	Finish	
	RLAL La Línea Linear Downlight	S Small	R Recessed	08 HP LED 8W	E On-Off D 0-10V Dimming	1 15°	B Black S Specular F Frosted C Champagne	WT White	
						2 28°			27 2700K
						3 36°			30 3000K 40 4000K

示例: RLALSR-08E-127BWT

Model	Size	Install	LED	Driver	Beam	CCT	Reflector	Finish	
	RLAL La Línea Linear Downlight	M Medium	R Recessed	16 LED 16W	E On-Off D 0-10V Dimming	1 15°	B Black S Specular F Frosted C Champagne	WT White BK Black	
						2 28°			27 2700K
						3 36°			30 3000K 40 4000K

示例: RLALMR-16E-127BWT

Model	Size	Install	LED	Driver	Beam	CCT	Reflector	Finish
	RLAW La Línea Linear Wall Washer	S Small	R Recessed	08 HP LED 8W	E On-Off D 0-10V Dimming	W Wall Washer	B Black W White	BK Black WT White
						27 2700K		
						30 3000K 40 4000K		

示例: RLAWSR-08E-W27BBK

Model	Size	Install	LED	Driver	Beam	CCT	Reflector	Finish
	RLAW La Línea Linear Wall Washer	M Medium	R Recessed	16 LED 16W	E On-Off D 0-10V Dimming	W Wall Washer	B Black W White	WT White BK Black
						27 2700K		
						30 3000K 40 4000K		

示例: RLAWMR-16E-W27BBK



TRACK SYSTEM 轨道系统

高压轨道系统 CECIO

Model	LED Power	Driver	Beam	CCT	Reflector	Finish
	RTBSS Cecio 高压轨道射灯	E On-Off D 0-10V Dimming	1 18°	30 3000K 40 4000K	B Black W White	WT White BK Black
			2 28°			
			3 36°			



示例: RTBSS-12E-130BBK

低压轨道系统 LA LÍNEA琳奈线条灯

Model	LED Power	Driver	Beam	CCT	Surface	Finish
	RTMB1 琳奈线条灯	E On-Off	A 面发光	30 3000K 40 4000K	N NA	BK Black
		A DALI		CC 可变色温		
	RTMB2 琳奈线条灯	E On-Off	3 36° 5 50°	30 3000K 40 4000K	B Black	BK Black
		A DALI		CC 可变色温		
	RTMB3 琳奈线条灯	E On-Off	3 36° 5 50°	30 3000K 40 4000K	B Black	BK Black
		A DALI		CC 可变色温		





示例: RTMB1-N-10E-A30NBK

低压轨道系统
LA LINEA琳奈线条灯





Model	LED Power	Driver	Beam	CCT	Surface	Finish
 RTMB5 琳奈线条灯	N-10 267mm 10W	A DALI	W 洗墙	CC 可变色温	B Black	BK Black 
	M-25 502mm 25W					
 RTMB4 琳奈线条灯	N-10 244mm 10W	A DALI	W 洗墙	CC 可变色温	B Black	BK Black 
	M-25 484mm 25W					

示例: RTMB1N-10E-A30NBK
· 48V 恒压输入



低压轨道系统
低压轨道射灯

Model	LED Power	Driver	Beam	CCT	Surface	Finish
 RTMA1S Lucio低压轨道射灯	06 6W	E ON-OFF	1 18° 2 28° 3 36°	30 3000K	B Black	BK Black 
				40 4000K	W White	WT White 
		A DALI		30 3000K	B Black	BK Black 
				40 4000K CC 可变色温	W White	WT White 



示例: RTMA1S-06E-130BWT
· 48V 恒压输入

Model	LED Power	Driver	Beam	CCT	Surface	Finish
 RTMA1M Lucio低压轨道射灯	25 25W	E ON-OFF	1 18° 2 28° 3 36°	30 3000K	B Black	BK Black 
				40 4000K	W White	WT White 
		A DALI		30 3000K	B Black	BK Black 
				40 4000K CC 可变色温	W White	WT White 

示例: RTMA1M-25E-130NWT
· 48V 恒压输入





Model	LED Power	Driver	Beam	CCT	Surface	Finish
 RTMA2M Cecio 低压轨道灯	15 15W	A DALI	2 28° 3 36°	CC 可变色温	B Black	BK Black 
			1 18° 2 28° 3 36°			

示例: RTMA2M-15A-2CCBBK
*48V 恒压输入

Model	LED Power	Driver	Beam Angle	CCT	Surface	Finish
 RTMA2M Cecio 低压轨道灯	15 15W	A DALI	F 电子变焦支持 20°-50°可调	CC 可变色温	B Black	BK Black 
					W White	WT White 

示例: RTMA2M-15A-FCCBBK
*48V 恒压输入





低压轨道系统
低压轨道吊灯

Model	LED Power	Driver	Beam	CCT	Surface	Finish
 RTMC1S Celine系列轨道吊灯	10 10W	E ON-OFF	1 18° 2 28° 3 36°	30 3000K 40 4000K	W White	WT White 
					B Black	BK Black 
		A DALI		30 3000K 40 4000K	W White	WT White 
				CC 可变色温	B Black	BK Black 





示例: RTMC1S-10E-130BBK
· 48V 恒压输入

LINEAR SYSTEM 线性系统





LED柔性灯带
阑藤

Model	LED Power	Driver	Beam	CCT	Surface	Finish
 RTMC25 Celine系列艺术吊灯	10 10W	E On-Off	1 18° 2 28° 3 36°	30 3000K	B Black	BK Black 
				40 4000K	W White	WT White 
		A DALI		30 3000K	B Black	BK Black 
				40 4000K	W White	WT White 
CC 可变色温						



示例: RTMC25-10E-130BBK
· 48V 恒压输入

Model	Size	LED Power	Driver	Beam	CCT	Surface	Finish
 RTMC4S Celine 系列轨道吊灯	S Small	08 8W	A DALI	F 20°-50°	CC 可变色温	X 与 finish 同色 D 磨砂装饰头	WT White 
							BK Black 
							BN 亮银色 
							BR 砂铜色 



示例: RTMC4S-08A-FCCXWT
*48V 恒压输入

Model	Size	LED Power	Driver	Beam	CCT	Surface	Finish
 RTMC4M Celine 系列轨道吊灯	M Medium	18 18W	A DALI	F 20°-50°	CC 可变色温	X 与 finish 同色 D 磨砂装饰头	WT 白色 
							BK 黑色 
							BN 亮银色 
							BR 砂铜色 



示例: RTMC4M-18A-FCCXWT
*48V 恒压输入

Model	LED Power	Driver	Beam	CCT	Surface	Finish
 RTMC3S Genesis 系列轨道吊灯	08 下出光 5W 上出光 3W	A DALI	2 28°	30 3000k	N NA	BN Brushed Nickel 
			3 36°			
			4 48°			
			A ≥100°			



示例: RTMC3S-08A-230NBN
*48V 恒压输入

Model	Length	IP	LED	Driver	Beam	CCT	Surface	Finish
 RSCL 阑藤系列灯带	5 5M	1 IP20	18 18W/M	T 24V DC	A ≥100°	YC RGB+2400K +6000K	N NA	WT White 
	1 1M							
	T 0.08M							

示例: RSCL11-18T-AYCNWT
*1M、5M 规格包装中附赠 1pcs 进电端接

Model	Length	IP	LED	Driver	Beam	CCT	Surface	Finish
 RSBL 青藤系列灯带	5 5M	1 IP20	20 20W/M	T 24V DC	A ≥100°	CC 2400K~6000K 可调色温	N NA	WT White 
	1 1M							
	T 0.1M							

示例: RSBL11-20T-ACCNWT
*1M、5M 规格包装中附赠 1pcs 进电端接

Model	Length	IP	LED	Driver	Beam	CCT	Surface	Finish
 RSAL 紫藤系列灯带	1 1M 5 5M	1 IP20	06 6W/M	T 24V DC	A ≥100°	27 2700K	N NA	WT White 
			10 10W/M			30 3000K		
			13 13W/M			35 3500K		
						40 4000K		

示例: RSAL11-06T-A27NWT
*1M、5M 规格包装中附赠 1pcs 进电端接

LED柔性灯带
青藤







LED柔性灯带
紫藤

线性明装灯具
LA LINEA琳奈

Model	Length	Driver	Beam	CCT	Surface	Finish
 RLCLNS 琳奈窗灯 250mm	04 4M	T 24V 恒压输入	2 28°	30 3000K 40 4000K	B Black	BK Black 
	08 8M		3 36°			
	RLCLSS 琳奈窗灯 500mm		16 16M		4 48°	WT White



示例: RLCLNS-04T-230BBK
*24V 恒压输入规格不含驱动器, 需外接电源

CEILING MOUNT LIGHT 吸顶灯
CELINE

Model	Size	Type	LED	Driver	Beam	CCT	Surface	Finish
 RCAL Ceiling Mount Downlight	S Small	C Cylinder	08 HP LED 8W	E ON-OFF	1 15°	27 2700K	B Black	WT White 
					2 24°	30 3000K	S Specular	
					3 36°	35 3500K	F Frosted	
					4 48°	40 4000K	C Champagne D Decorative	
 RCAL Ceiling Mount Downlight	M Medium	C Cylinder	13 COB 13W	E ON-OFF	2 20°	27 2700K	B Black	WT White 
					4 40°	30 3000K	S Specular	
					6 60°	35 3500K	F Frosted	
						40 4000K	C Champagne D Decorative	
 RCAL Surface Mount Downlight	L Large	C Cylinder	18 COB 18W	E ON-OFF	2 20°	27 2700K	B Black	WT White 
			25 COB 25W		4 40°	30 3000K	S Specular	
					6 60°	35 3500K	F Frosted	
					40 4000K	C Champagne		



示例: RCALSC-08E-127BWT

VAUGHAN

Model	LED Power	Driver	Beam	CCT	Surface	Finish
 RCAAMA VAUGHAN系列吸顶灯	27 27W	E ON-OFF	A ≥100°	30 3000K	P NA	BN Brushed Nickel 
						AB Aged Brass 

示例: RCAAMA-27E-A30PBN

PENDENT LIGHT 吊灯
BRANWEN

Model	LED Power	Driver	Beam	CCT	Surface	Finish
 RPELSA BRANWEN 系列吊灯	05 5W	T 24V恒压输入	A ≥100°	30 3000K	P NA	CH Chrome 

示例: RPELSA-05T-A30PCH
*24V 恒压输入规格不含驱动器, 需外接电源

BOLLA

Model	LED Power	Driver	Beam	CCT	Surface	Finish
 RPEMSA BOLLA系列吊灯	04 4W	T 24V恒压输入	A ≥100°	30 3000K	P NA	CH Chrome 

示例: RPEMSA-04T-A30PCH
*24V 恒压输入规格不含驱动器, 需外接电源

TIC TOC

Model	LED Power	Driver	Beam	CCT	Surface	Finish
 RPEFSA TIC TOC 系列吊灯	08 8W	T 24V恒压输入	A ≥100°	30 3000K	P NA	AL Brushed Aluminum 

示例: RPEFSA-08T-A30PAL
*24V 恒压输入规格不含驱动器, 需外接电源

CHANDRA

Model	LED Power	Driver	Beam	CCT	Surface	Finish
 RPEHSA CHANDRA 系列吊灯	07 7W	T 24V恒压输入	A ≥100°	30 3000K	P NA	BK Black  AB Aged Brass 

示例: RPEHSA-07T-A30PBK
*24V 恒压输入规格不含驱动器, 需外接电源

LAUREL

Model	LED Power	Driver	Beam	CCT	Reflector	Finish
 RPENSA LAUREL 系列吊灯	11 11W	T 24V恒压输入	A ≥100°	30 3000K	P NA	BK Black  BN Brushed Nickel 

示例: RPENSA-11T-A30PBK
*24V 恒压输入规格不含驱动器, 需外接电源

CHRYSALIS

Model	LED Power	Driver	Beam	CCT	Reflector	Finish
 RPEKSA CHRYSALIS 系列吊灯	04 4W	T 24V恒压输入	A ≥100°	30 3000K	P NA	BK Black  BN Brushed Nickel 

示例: RPEKSA-04T-A30PBN
*24V 恒压输入规格不含驱动器, 需外接电源

CRATER

Model	LED Power	Driver	Beam	CCT	Reflector	Finish
 RPERSA CRATERA 系列吊灯	03 3W	T 24V恒压输入	A ≥100°	35 3500K	P NA	AB Aged Brass 

示例: RPERSA-03T-A35PAB
*24V 恒压输入规格不含驱动器, 需外接电源

ACTION

Model	LED Power	Driver	Beam	CCT	Surface	Finish
 RPEPSA ACTION 系列吊灯	06 6W	T 24V恒压输入	A ≥100°	30 3000K	P NA	AB Aged Brass  BK Black  CH Chrome 

示例: RPEPSA-06T-A30PAB
*24V 恒压输入规格不含驱动器, 需外接电源

NAPA

Model	LED Power	Driver	Beam	CCT	Surface	Finish
 RPECSA NAPA 系列吊灯	10 10W	T 24V恒压输入	A ≥100°	30 3000K	P NA	BK Black 

示例: RPECSA-10T-A30PBK
*24V 恒压输入规格不含驱动器, 需外接电源

MARQUES

Model	LED Power	Driver	Beam	CCT	Reflector	Finish
 RPDFM1 Marques 吊灯	35 35W	T 24V恒压输入	A ≥100°	30 3000K	P NA	AB Aged Brass  BK Black 

示例: RPDFM1-35T-A30PBK
*24V 恒压输入规格不含驱动器, 需外接电源

Model	LED Power	Driver	Beam	CCT	Surface	Finish
 RPDFM2 Marques 吊灯	35 35W	T 24V 恒压输入	A ≥100°	30 3000K	P NA	AB Aged Brass  BK Black 

ECHO

Model	LED Power	Driver	Beam	CCT	Surface	Finish
 RPBFM2 Echo 吊灯	07 07W	T 24V 恒压输入	A ≥100°	30 3000K	N NA	BN Brushed Nickel 

示例: RPBFM2-07T-A30NBN
*24V 恒压输入规格不含驱动器, 需外接电源

TIGHTROPE

Model	LED Power	Driver	Beam	CCT	Surface	Finish
 RPDFM3 Marques 吊灯	25 25W	T 24V 恒压输入	A ≥100°	30 3000K	P NA	BK Black 

示例: RPDFM3-25T-A30PBK
*24V 恒压输入规格不含驱动器, 需外接电源

EFFERVESCENT

Model	LED Power	Driver	Beam	CCT	Surface	Finish
 RPDLM1 Effervescent 吊灯	25 25W	T 24V 恒压输入	A ≥100°	30 3000K	N NA	BK Black  AL Brushed Aluminum 





示例: RPDLM1-25T-A30NBK
*24V 恒压输入规格不含驱动器, 需外接电源





GENESIS

Model	LED Power	Driver	Beam	CCT	Surface	Finish
 RPBDSA Genesis 水晶吊灯	08 下出光5W 上出光3W	D 220V 输入 0-10V 调光 T 24V 恒压输入	2 28° 3 36° 4 48° A ≥100°	30 3000K	N NA	BN Brushed Nickel 

示例: RPBDSA-08D-A30NBN
*24V 恒压输入规格不含驱动器, 需外接电源



LORA

Model	Power(W)	Dimming	Beam	CCT	Reflector	Finish
 RPALMR	16 16W	W WiFi	A ≥100°	CC 2700K-4000K 可调	P Panel 面出光	WT Opal White 宁静白  LC Living Cora 珊瑚橘  BB Bugle Blue 号角蓝  EG Emerald Green 松石绿 

Model	Power(W)	Dimming	Beam	CCT	Reflector	Finish
 RPALLR	25 25W	W WiFi	A ≥100°	CC 2700K-4000K 可调	P Panel 面出光	WT Opal White 宁静白  LC Living Cora 珊瑚橘  BB Bugle Blue 号角蓝  EG Emerald Green 松石绿 

示例: : RPALLR-25W-ACCPWT

LA LÍNEA琳奈

Model	Size	Type	LED	Driver	Beam	CCT	Reflector	Finish
 RPDD La Línea series Pendant	S Small	L Linear	50 50W	B Wireless Dimming	9 90°	30 3000K 40 4000K	P Panel	WT White  CB Copper Bronze 

示例: RPDML-64B-930PWT

LA LÍNEA PRO

Model	Size	Type	LED	Driver	Beam	CCT	Reflector	Finish
 RPDD La Línea series Pendent	M Medium	L Linear	64 64W	B Wireless Dimming	9 90°	30 3000K	P Panel	WT White
						40 4000K		

Model	LED Power	Driver	Beam	CCT	Reflector	Finish
 RPEDML	35 35W	S Sensor	A ≥100°	CC 色温可切换	P 面出光	BK Black

示例: RPEDML-35S-ACCPBK
*24V 恒压输入

CELINE

Model	Size	Type	LED	Driver	Beam	CCT	Reflector	Finish
 RPCL Celine Series Downlight	S Small	C Cylinder	08 HP LED 8W	E ON-OFF	F 20°-50°	27 2700K	X 与 Finish 同色	WT White
						30 3000K		BK Black
						35 3500K		BN Brushed Nickel
						40 4000K		BR Brushed Brass

Model	Size	Type	LED	Driver	Beam	CCT	Reflector	Finish
 RPCL Celine Series Pendant Downlight	M Medium	C Cylinder	13 LED 13W	E ON-OFF	F 20°-50°	27 2700K	X 与 Finish 同色	WT White
			18 LED 18W			30 3000K		BK Black
						35 3500K		BN Brushed Nickel
						40 4000K		BR Brushed Brass

示例: RPCLSC-08E-F27XWT

FLOOR LIGHT 落地灯

LORA

Model	LED Power	Dimming	Beam	CCT	Reflector	Finish
 RFALLR	32 32W	W Smart Dimming	A ≥100°	CC 2700K-4000K 连续可调色温	P 面出光	WT Opal White 宁静白

示例: RFALLR-32W-ACCPWT





ELLINGTON

Model	LED Power	Driver	Beam	CCT	Surface	Finish
 RPBFS1 Ellington 吊灯	05 5W	T 24V 恒压输入	A ≥100°	30 3000K	N NA	AB Aged Brass
						BN Brushed Nickel

示例: RPBFS1-05T-A30NAB
*24V 恒压输入规格不含驱动器, 需外接电源

LA LÍNEA PRO

Model	LED Power	Driver	Beam	CCT	Reflector	Finish
 RFBLLR	20 20W	S Sensor	A ≥100°	CC 色温可切换	P 面出光	BK Black

Model	LED Power	Driver	Beam	CCT	Reflector	Finish
 RFBLLR	35 35W	S Sensor	A ≥100°	CC 色温可切换	P 面出光	BK Black 
 RFBLLR	45 45W	S Sensor	A ≥100°	CC 色温可切换	P 面出光	BK Black 

示例: RFBLLR-20S-ACCPBK
*24V 恒压输入

TABLE LIGHT 台灯

LORA

Model	LED Power	Driver	CCT	Beam	Reflector	Finish
 RRALM LORA 台灯	20 20W	W WiFi	CC 2700K-4000K可调	A ≥100°	P Panel	WT Opal White 宁静白  LC Living Cora 珊瑚橘  BB Bugle Blue 号角蓝  EG Emerald Green 松石绿 

示例: RRALM-20W-CCAPWT

WALL LIGHT 壁灯

DUET

Model	LED Power	Driver	Beam	CCT	Surface	Finish
 RWBCSA DUET 系列壁灯	11 11W	T 24V 恒压输入	A ≥100°	30 3000K	P NA	BK Black  WT White 



示例: RWBCSA-11T-A30PBK
*默认 3000K、2700K、3500K 通过灯具背部拨码开关进行调节
*24V 恒压输入规格不含驱动器, 需外接电源

LAYNE

Model	LED Power	Driver	Beam	CCT	Surface	Finish
 RWBFSA LAYNE 系列壁灯	07 7W	T 24V 恒压输入	A ≥100°	27 2700K 30 3000K 35 3500K	P NA	BK Black 

示例: RWBFSA-07T-A27PBK
*24V 恒压输入规格不含驱动器, 需外接电源

SLEEPLESS

Model	LED Power	Driver	Beam	CCT	Surface	Finish
 RWBNSA SLEEPLESS系列壁灯	13 13W	E ON-OFF	A ≥100°	30 3000K	P NA	BK Black 
RWBNMA SLEEPLESS系列壁灯	17 17W					

示例: RWBNSA-13E-A30PBK

COLLETTE

Model	LED Power	Driver	Beam	CCT	Surface	Finish
 RWBBSA COLLETTE 系列壁灯	10 10W	T 24V 恒压输入	A ≥100°	30 3000K	P NA	AB Aged Brass  BK Black  BN Brushed Nickel  WT White 





示例: RWBBSA-10T-A30PAB
*默认 3000K、2700K、3500K 通过灯具背部拨码开关进行调节
*24V 恒压输入规格不含驱动器, 需外接电源

MYLIE

Model	LED Power	Driver	Beam	CCT	Surface	Finish
 RWBKSA MYLIE 系列壁灯	13 13W	T 24V 恒压输入	A ≥100°	30 3000K	P NA	AB Aged Brass  BN Brushed Nickel 

示例: RWBKSA-13T-A30PAB
*24V 恒压输入规格不含驱动器, 需外接电源

CORNICE

Model	LED Power	Driver	Beam	CCT	Surface	Finish
 RWBASA CORNICE 系列壁灯	09 9W	T 24V恒压输入	A ≥100°	30 3000K	P NA	AB Aged Brass  BK Black  WT White 

示例: RWBASA-09T-A30PAB
*默认 3000K, 2700K, 3500K 通过灯具背部拨码开关进行调节
*24V 恒压输入规格不含驱动器, 需外接电源

CAMELOT

Model	LED Power	Driver	Beam	CCT	Surface	Finish
 RWBDSA CAMELOT 系列壁灯	09 9W	T 24V恒压输入	A ≥100°	30 3000K	P NA	BK Black  AB Aged Brass 

示例: RWBDSA-09T-A30PAB
*24V 恒压输入规格不含驱动器, 需外接电源

POCKET

Model	LED Power	Driver	Beam	CCT	Surface	Finish
 RWBMSA POCKET 系列壁灯	15 15W	T 24V恒压输入	A ≥100°	30 3000K	P NA	BK Black  AB Aged Brass  BN Brushed Nickel  WT White 



示例: RWBMSA-15T-A30PAB
*24V 恒压输入规格不含驱动器, 需外接电源

BLANCE

Model	LED Power	Driver	Beam	CCT	Surface	Finish
 RWALM3 Balance 壁灯	08 8W	T 24V恒压输入	A ≥100°	30 3000K 40 4000K	P NA	BK Black  WT White  AL Brushed Aluminum 



示例: RWALM3-08T-A30PWT
*24V 恒压输入规格不含驱动器, 需外接电源

BOXI

Model	LED Power	Driver	Beam	CCT	Surface	Finish
 RWALM1 Boxi 壁灯	08 8W	T 24V恒压输入	A ≥100°	30 3000K 40 4000K	P NA	BK Black  WT White 

示例: RWALM1-08T-A30PWT
*24V 恒压输入规格不含驱动器, 需外接电源

ATLANTIS

Model	LED Power	Driver	Beam	CCT	Surface	Finish
 RWALM2 ATLANTIS 壁灯	08 8W	T 24V恒压输入	A ≥100°	30 3000K 40 4000K	P NA	BK Black  WT White  AL Brushed Aluminum 

示例: RWALM2-08T-A30PWT
*24V 恒压输入规格不含驱动器, 需外接电源

BLOK

Model	LED Power	Driver	Beam	CCT	Surface	Finish
 RWBLSA BLOK 系列壁灯	24 24W	T 24V恒压输入	A ≥100°	27 2700K 30 3000K 35 3500K	P NA	BK Black  SN Satin Nickel  WT White 

示例: RWBLSA-24T-A27PWT
*24V 恒压输入规格不含驱动器, 需外接电源

MAVEN

Model	LED Power	Driver	Beam	CCT	Surface	Finish
 RWBISA MAVEN 系列壁灯	15 15W	T 24V恒压输入	A ≥100°	30 3000K	P NA	BN Brushed Nickel 

示例: RWBISA-15T-A30PBN
*24V 恒压输入规格不含驱动器, 需外接电源

MIRROR HEAD LIGHT 镜前灯

PARALLAX

Model	LED Power	Driver	Beam	CCT	Surface	Finish
 RWALM4 PARALLAX 镜前灯 457mm	06 6W	T 24V恒压输入	A ≥100°	27 2700K	P NA	BK Black
				30 3000K		BN Brushed Nickel
RWALM5 PARALLAX 镜前灯 610mm				35 3500K		CH Chrome

示例: RWALM4-06T-A27PBK
*24V 恒压输入规格不含驱动器, 需外接电源

JASMINE

Model	LED Power	Driver	Beam	CCT	Surface	Finish
 RWALM6 JASMINE 系列镜前灯	08 8W 686mm	T 24V恒压输入	A ≥100°	30 3000K	P NA	BK Black
	12 12W 941mm					CH Chrome

示例: RWALM6-08T-A30PBK
*24V 恒压输入规格不含驱动器, 需外接电源

PHOTO LIGHT 照画灯

REED

Model	LED Power	Driver	Beam	CCT	Surface	Finish
 RWCASL REED 系列镜前灯	16 16W	E ON-OFF	A ≥100°	30 3000K	P NA	BK Black
	18 18W					BN Brushed Nickel
	25 25W					

示例: RWCASL-16E-A30PBN

HUDSON

Model	LED Power	Driver	Beam	CCT	Surface	Finish
 RWCBSL HUDSON 系列镜前灯	12 12W	E ON-OFF	A ≥100°	30 3000K	P NA	BK Black
	16 16W					AB Aged Brass
	22 22W					

示例: RWCBSL-12E-A30PBK

STEP LIGHT 踢脚灯

Model	LED Power	Driver	Beam	CCT	Finish
 RW211 Step Light	01 1W	E ON-OFF 220V AC Power Supply	A ≥100°	27 2700K	WT White Coat
				30 3000K	

示例: RW110-05E-D27WT

Model	LED Power	Driver	Beam	CCT	Finish
 RW202 Step Light	01 1W	E ON-OFF 220V AC Power Supply	A ≥100°	30 3000K	BK Black On Aluminum
					BN Brushed Nickel On Aluminum
					BZ Bronze On Aluminum
					SS Stainless Steel
					WT White On Aluminum

示例: RW202-01E-A30BK

LANDSCAPE户外景观灯

LANDSCAPE泛光灯
WALL WASH 全彩洗墙

Model	Power	Driver	Beam Angle	CCT	Surface	Finish
 U5021 Wall Wash	0.5-14.5W	12V AC	15°-50°X80°	CC Color Change	/	BBR Bronze on Brass

示例: U5021-CCBBR

LOW PROFILE LINEAR 6W

Model	Power	Driver	Beam Angle	CCT	Surface	Finish
 U6401 Low Profile Linear	6W	12V AC	80°-110°	27 2700K 30 3000K	/	BZ Bronze on Aluminum

示例: U6401-27BK

INTERBEAM 可变焦

Model	Power	Driver	Beam Angle	CCT	Surface	Finish
 U5411 InterBeam	3W	12V AC	20°/35°/60° 三档旋钮可调节	27 2700K 30 3000K	/	BK Black on Aluminum BZ Bronze on Aluminum

 U5311 InterBeam	6W	12V AC	20°/35°/60° 三档旋钮可调节	27 2700K 30 3000K	/	BK Black on Aluminum BZ Bronze on Aluminum
---	----	--------	------------------------	----------------------	---	---

示例: U5311-27BK

MINI WALL WASH 8W 洗墙

Model	Power	Driver	Beam Angle	CCT	Surface	Finish
 U5121 Mini Wall Wash	1W-8W 旋钮可调节	12V AC	70° x 95°	27/30 2700K/3000K 旋钮可调节	/	BK Black on Aluminum BZ Bronze on Aluminum BBR Bronze on Brass

示例: U5121-27/30BK

WALL WASH 18W 洗墙

Model	Power	Driver	Beam Angle	CCT	Surface	Finish
 U5021 Wall Wash	1W-18W 旋钮可调节	12V AC	15°-50°X80°	27 2700K 30 3000K	/	BK Black on Aluminum BZ Bronze on Aluminum BBR Bronze on Brass

示例: U5021-27BK

LANDSCAPE埋地灯
FUGO 3" 14W 全彩 圆形

Model	Power	Driver	Beam Angle	CCT	Surface	Finish
 U5031 3" Inground	0.5W-14.5W	12V AC	15°-60°	CC Color Change	/	BBR Bronze on Brass

 U5031 3" Inground	2W-12W 旋钮可调节	12V AC	20°-60° 三档旋钮可调节	27 2700K 30 3000K	/	BZ Bronze on Aluminum BBR Bronze on Brass
---	-----------------	--------	--------------------	----------------------	---	--

示例: U5031-CCBBR

FUGO 2" 3W 圆形超薄 格栅出光

Model	Length	IP	Power	Driver	Beam Angle	CCT	Surface	Finish
 U2511 Louver	/	IP67	2.8W	12VAC	90°	27 2700K 30 3000K	/	SS Stainless Steel BS Bronzed Stainless Steel

示例: U2511-30SS

FUGO 2" 圆形(超薄) 单侧出光

Model	Length	IP	Power	Driver	Beam Angle	CCT	Surface	Finish
 U2091 Single Direction	/	IP67	4.1W	12VAC	≥100°	27 2700K 30 3000K	/	SS Stainless Steel BS Bronzed Stainless Steel

示例: U2091-27SS

Model	Length	IP	Power	Driver	Beam Angle	CCT	Surface	Finish
 U2591 Single Directional	/	IP67	2.8W	12VAC	110°	27 2700K 30 3000K	/	SS Stainless Steel BS Bronzed Stainless Steel

FUGO 2" 3W 圆形超薄 双侧出光

Model	Length	IP	Power	Driver	Beam Angle	CCT	Surface	Finish
 U2571 Bi-Directional	/	IP67	2.8W	12VAC	180°	27 2700K 30 3000K	/	SS Stainless Steel BS Bronzed Stainless Steel

示例: U2571-30SS

FUGO 2" 4W 圆形 双侧出光

Model	Length	IP	Power	Driver	Beam Angle	CCT	Surface	Finish
 U2071 Bi-Directional	/	IP67	4.1W	12VAC	≥100°	27 2700K 30 3000K	/	SS Stainless Steel BS Bronzed Stainless Steel

示例: U2071-27SS

FUGO 2" 3W 4W 圆形(超薄) 单侧出光

Model	Length	IP	Power	Driver	Beam Angle	CCT	Surface	Finish
 U2541 Step	/	IP67	2.8W	12VAC	90°	27 2700K 30 3000K	/	SS Stainless Steel BS Bronzed Stainless Steel

示例: U2541-30SS

Model	Length	IP	Power	Driver	Beam Angle	CCT	Surface	Finish
 U2041 Circle Step	/	IP67	4.1W	12VAC	≥100°	27 2700K 30 3000K	/	SS Stainless Steel BS Bronzed Stainless Steel

FUGO 2" 3W 圆形超薄 四侧出光

Model	Length	IP	Power	Driver	Beam Angle	CCT	Surface	Finish
 U2501 Quad-Directional	/	IP67	2.8W	12VAC	180°	27 2700K 30 3000K	/	SS Stainless Steel BS Bronzed Stainless Steel

示例: U2501-30SS

FUGO 2" 4W 圆形 四侧出光

Model	Length	IP	Power	Driver	Beam Angle	CCT	Surface	Finish
 U2101 Quad-Direction	/	IP67	4.1W	12V AC	≥100°	27 2700K 30 3000K	/	SS Stainless Steel BS Bronzed Stainless Steel

示例: U2101-27SS

FUGO 2" 4W 单侧面出光

Model	Length	IP	Power	Driver	Beam Angle	CCT	Surface	Finish
 U2081 Hood	/	IP67	4.1W	12V AC	≥100°	27 2700K 30 3000K	/	SS Stainless Steel BS Bronzed Stainless Steel

示例: U2081-27SS

FUGO 2" 4W 窄边框

Model	Length	IP	Power	Driver	Beam Angle	CCT	Surface	Finish
 U2011 Slim round	/	IP67	4.1W	12V AC	25°	27 2700K 30 3000K	/	SS Stainless Steel BS Bronzed Stainless Steel

示例: U2011-27SS

FUGO 1" 2W 窄边框

Model	Length	IP	Power	Driver	Beam Angle	CCT	Surface	Finish
 U1011 slim round	/	IP67	1.9W	12V AC	50°	27 2700K 30 3000K	/	SS Stainless Steel

示例: U1011-27SS

FUGO 2" 5W 半圆形遮蔽出光

Model	Length	IP	Power	Driver	Beam Angle	CCT	Surface	Finish
 U2131 Scoop	/	IP67	5W	12V AC	45°	27 2700K 30 3000K	/	SS Stainless Steel BS Bronzed Stainless Steel

示例: U2131-27SS

FUGO 2" 5W 圆形 格栅出光

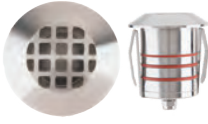
Model	Length	IP	Power	Driver	Beam Angle	CCT	Surface	Finish
 U2121 Louver	/	IP67	5W	12V AC	45°	27 2700K 30 3000K	/	SS Stainless Steel BS Bronzed Stainless Steel

示例: U2121-27SS

FUGO 1" 2W 半圆形遮蔽出光

Model	Length	IP	Power	Driver	Beam Angle	CCT	Surface	Finish
 U1061 Scoop	/	IP67	1.9W	12V AC	45°	27 2700K 30 3000K	/	SS Stainless Steel BS Bronzed Stainless Steel

示例: U1061-27SS

FUGO 1" 2W 格栅遮蔽出光

Model	Length	IP	Power	Driver	Beam Angle	CCT	Surface	Finish
 U1041 Louver	/	IP67	1.9W	12V AC	45°	27 2700K 30 3000K	/	SS Stainless Steel BS Bronzed Stainless Steel



示例: U1041-27SS

LANDSCAPE壁灯
ESTRELLA 7.5W 双头出光 壁灯

Model	Power	Driver	Beam Angle	CCT	Surface	Finish
 U3831 Estrella	1W-7.5W 旋钮可调节	12V AC	35°/45°/55° 三档旋钮可调节	27 2700K 30 3000K 40 4000K 三档旋钮可调节	/	BK Black  BZ Bronze  WT White 







示例: U3831-27/30/40BK

CYLINDER 7.5W 双头出光 壁灯

Model	Power	Driver	Beam Angle	CCT	Surface	Finish
 U3611 Cylinder	7.5W	12V AC	35°/45°/55° 三档旋钮可调节	27 2700K 30 3000K 40 4000K 三档旋钮可调节	/	BK Black  BZ Bronze  WT White 





示例: U3611-27/30/40BK

SCOOP 16W 单头出光 壁灯

Model	Power	Driver	Beam Angle	CCT	Surface	Finish
 UWS-W20506 Scoop	16W	220V AC 50/60HZ	≥100°	30 3000K	/	AL Brushed Aluminum  GH Graphite  BK Black  BZ Bronze  WT White 





示例: UWS-W20506-AL

FIN 壁灯

Model	Power	Driver	Beam Angle	CCT	Surface	Finish
 UWP-LED219-30 HAWK	19W	220V AC 50/60HZ	≥100°	30 3000K	/	AGH Architectural Graphite  ABZ Architectural Bronze  AWT Architectural White 





示例: UWP-LED219-30-ABZ



FIN 壁灯



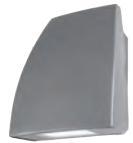

Model	Power	Driver	Beam Angle	CCT	Surface	Finish
 UWP-LED227-30 HAWK	27W	220V AC 50/60HZ	≥100°	30 3000K	/	AGH Architectural Graphite  ABZ Architectural Bronze  AWT Architectural White 

示例: UWP-LED219-30-ABZ

FIN 壁灯







Model	Power	Driver	Beam Angle	CCT	Surface	Finish
 UWP-LED119-30 Fin	19W	220V AC 50/60HZ	≥100°	30 3000K	/	AGH Architectural Graphite  ABZ Architectural Bronze  AWT Architectural White 

Model	Power	Driver	Beam Angle	CCT	Surface	Finish
 UWP-LED127-30 Fin	27W	220V AC 50/60HZ	≥100°	30 3000K	/	AGH Architectural Graphite  ABZ Architectural Bronze  AWT Architectural White 

Model	Power	Driver	Beam Angle	CCT	Surface	Finish
 UWP-LED135-30 Fin	35W	220V AC 50/60HZ	≥100°	30 3000K	/	AGH Architectural Graphite  ABZ Architectural Bronze  AWT Architectural White 

示例: UWP-LED119-30-ABZ

TUBE 壁灯

Model	Power	Driver	Beam Angle	CCT	Surface	Finish
 UFM-W2612 Tube	30W	220V AC 50/60HZ	≥100°	30 3000K	/	AL Brushed Aluminum  GH Graphite  BK Black  BZ Bronze  WT White 

示例: UFM-W2612-AL



UFM-W2605
Tube

16W

220V AC
50/60HZ

≥100°

30 3000K

/

- AL Brushed Aluminum
- GH Graphite
- BK Black
- BZ Bronze
- WT White

示例: UFM-W2605-AL

LANDSCAPE壁灯
ESTRELLA 吸顶下照吊灯

Model Power Driver Beam Angle CCT Surface Finish



U3821
Estrella

1W-7.5W
旋钮可调节

12V AC

35°/45°/55°
三档旋钮可调节

27 2700K
30 3000K
40 4000K
三档旋钮可调节

/

- BK Black
- BZ Bronze



U3811
Estrella

1-7.5W
旋钮可调节

12V AC

35°/45°/55°
三档旋钮可调节

27 2700K
30 3000K
40 4000K
三档旋钮可调节

/

- BK Black
- BZ Bronze

示例: U3821-27/30/40BK

TUBE 16W 吸顶下照吊灯

Model Power Driver Beam Angle CCT Surface Finish



UPD-W2605
Tube

16W

220V AC
50/60HZ

≥100°

30 3000K

/

- AL Brushed Aluminum
- GH Graphite
- BK Black
- BZ Bronze
- WT White

示例: UPD-W2605-AL

LANDSCAPE踢脚灯
SRUFACE MOUNTER 明装踢脚灯

Model Power Driver Beam Angle CCT Surface Finish



U4901
Surface Mounted

8W

12V AC

≥100°

27 2700K
30 3000K

/

- BBR Bronze on Brass
- BK Black
- BZ Bronze
- WT White



U4501
Surface Mounted

4W

12V AC

≥100°

27 2700K
30 3000K

/

- BBR Bronze on Brass
- BK Black
- BZ Bronze
- WT White

示例: U4501-27BBR

RECTANGLE 踢脚灯

Model Power Driver Beam Angle CCT Surface Finish



U4091
Rectangle

2W

12V AC

≥100°

27 2700K
30 3000K
AM Amber

/

- BK Black
- BZ Bronze
- WT White

示例: U4091-27BK

CIRCLE 踢脚灯

Model Power Driver Beam Angle CCT Surface Finish



U3011
Circle

2.8W

12V AC

≥100°

27 2700K
30 3000K

/

- BBR Bronze on Brass
- BK Black
- BZ Bronze
- WT White

示例: U3011-27BK

TRIANGLE 踢脚灯

Model	Power	Driver	Beam Angle	CCT	Surface	Finish
 U3021 Triangle	2.8W	12V AC	≥100°	27 2700K 30 3000K	/	BBR Bronze on Brass BK Black BZ Bronze WT White

示例: U3021-27BK

Model	LED Power	Driver	Beam	CCT	Finish
 RW300 Step Light	05 5W	E ON-OFF 220V AC Power Supply	A ≥100°	27 2700K 30 3000K 40 4000K	WT White BK Black Coat BZ Bronze BN Brushed Nickel

Model	LED Power	Driver	Beam	CCT	Finish
 RW310 Step Light	05 5W	E ON-OFF 220V AC Power Supply	A ≥100°	27 2700K 30 3000K 40 4000K	WT White Coat BK Black Coat BZ Bronze BN Brushed Nickel

Model	LED Power	Driver	Beam	CCT	Finish
 RW100 Step Light	05 5W	E ON-OFF 220V AC Power Supply	A ≥100°	27 2700K 30 3000K 40 4000K	WT White Coat BK Black Coat BZ Bronze BN Brushed Nickel

Model	LED Power	Driver	Beam	CCT	Finish
 RW110 Step Light	05 5W	E ON-OFF 220V AC Power Supply	D Directional	27 2700K 30 3000K 40 4000K	WT White Coat BK Black Coat BZ Bronze BN Brushed Nickel

示例: RW300-05E-A27WT

Model	LED Power	Driver	Beam	CCT	Finish
 RW130 Step Light	04 4W	E ON-OFF 220V AC Power Supply	F Frosted	27 2700K 30 3000K 40 4000K	WT White Coat BK Black Coat BZ Bronze BN Brushed Nickel

Model	LED Power	Driver	Beam	CCT	Finish
 RW200 Step Light	05 5W	E ON-OFF 220V AC Power Supply	A ≥100°	27 2700K 30 3000K 40 4000K	WT White Coat BK Black Coat BZ Bronze BN Brushed Nickel

Model	LED Power	Driver	Beam	CCT	Finish
 RW210 LEDme Series Step Light	05 5W	E ON-OFF 220V AC Power Supply	D Directional	27 2700K 30 3000K 40 4000K	WT White Coat BK Black Coat BZ Bronze BN Brushed Nickel

示例: RW130-04E-F27WT

LANDSCAPE水下灯
FUGO 水下明装圆形

Model	Length	IP	Power	Driver	Beam Angle	CCT	Surface	Finish
 U2031 Submersible Round	/	IP68	4.1W	12V AC	25°	30 3000K	/	SS Stainless Steel

示例: U2031-30SS

LANDSCAPE线性系统
INVISILED RGB 柔性灯带

Model	Length	IP	LED	Driver	Beam	CCT
 ULED-TCO InvisILED RGB 灯带	1 30cm	IP68	1.5W/30cm	24V DC	115°	RGB
	5 150cm					
	10 300cm					

示例: ULED-TCO-1-RGB

INVISILED 白光柔性灯带

Model	Length	IP	LED	Driver	Beam	CCT	Finish
 UT24-OD1 InvisILED 灯带	1 30cm	IP65	1.2W/30cm	24V DC	115°	27 2700K	BK Black
	5 150cm					30 3000K	
	10 300cm					40 4000K	
	20 600cm						
	40 1200cm						
80 2400cm							

示例: UT24-OD1-01-27

LANDSCAPE TAPE 白光柔性灯带

Model	Length	IP	LED	Driver	Beam	CCT	Finish
 U8 室外灯带	011 30cm	IP68	2W/30cm	12V AC	110°	27 2700K	BK Black
	051 150cm					30 3000K	
	101 300cm						
 U8 室外灯带	011 30cm	IP68	2W/30cm	12V AC	110°	27 2700K	BK Black
	051 150cm					30 3000K	
	101 300cm						
 U8 室外灯带	011 30cm	IP68	2W/30cm	12V AC	110°	27 2700K	BK Black
	051 150cm					30 3000K	
	101 300cm						



示例: U8011-27BK

INVISILED PRO 白光柔性灯带

Model	Length	IP	LED	Driver	Beam	CCT	Finish
 ULED-TO24 InvisILED Pro 灯带	1 30cm	IP68	3.5W/30cm	24V DC	110°	27 2700K	BK Black
	5 150cm					30 3000K	
	10 300cm					35 3500K	

示例: ULED-TO2427-1-WT

HARDSCAPE 线性灯

Model	Power	Driver	Beam	CCT	Finish
 U7062 Hardscape 6IN	4.5W 可旋钮调节亮暗	12V AC	≥110°	27 2700K	BBR Bronze on Brass BK Black BZ Bronze GH Graphite SD Sand on Aluminum
				30 3000K 可旋钮调节	
 U7122 Hardscape 12IN	7.5W 可旋钮调节亮暗	12V AC	≥110°	27 2700K	BBR Bronze on Brass BK Black BZ Bronze GH Graphite SD Sand on Aluminum
				30 3000K 可旋钮调节	
 U7182 Hardscape 18IN	8.5W 可旋钮调节亮暗	12V AC	≥110°	27 2700K	BBR Bronze on Brass BK Black BZ Bronze GH Graphite SD Sand on Aluminum
				30 3000K 可旋钮调节	
 U7032 Hardscape 3IN	1.5W 可旋钮调节亮暗	12V AC	≥110°	27 2700K	BK Black BZ Bronze GH Graphite SD Sand on Aluminum
				30 3000K	

示例: 7062-27/30BBR

LANDSCAPE矮柱灯
MIRAGE 幻影

Model	LED Power	Driver	Beam	CCT	Surface	Finish
 REBJ52 户外庭院灯	22 22W	E ON-OFF	A ≥100°	30 3000K	B Black	BK Black BZ Bronze

示例: REBJ52-22E-A30BBK

CANOPY

Model	LED Power	Driver	Beam	CCT	Surface	Finish
 REBA31 户外矮柱灯	06 6W	E ON-OFF	A ≥100°	27 2700K 30 3000K 40 4000K	N NA	BK Black BZ Bronze

示例: REBA31-06E-A27NBK

Model	Power	Driver	Beam Angle	CCT	Surface	Finish
 U6053 Canopy	6.5W	12V AC	≥100°	27 2700K 30 3000K	/	BBR Bronze on Brass BK Black BZ Bronze

示例: U6053-27BBR

PARK

Model	LED Power	Driver	Beam	CCT	Surface	Finish
 REBG42 户外矮柱灯	10 10W	E ON-OFF	A ≥100°	27 2700K 30 3000K 40 4000K	N NA	BK Black BZ Bronze

示例: REBG42-10E-A27NBK

CHAMBER

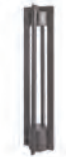
Model	LED Power	Driver	Beam	CCT	Surface	Finish
 REBE41 户外矮柱灯	10 10W	E ON-OFF	A ≥100°	27 2700K 30 3000K 40 4000K	N NA	BK Black BZ Bronze

示例: REBE41-10E-A27NBK

QUAD

Model	LED Power	Driver	Beam	CCT	Surface	Finish
 REBC42 户外矮柱灯	06 6W	E ON-OFF	A ≥100°	27 2700K 30 3000K 40 4000K	N NA	BK Black BZ Bronze

示例: REBC42-06E-A27NBK

GATE

Model	LED Power	Driver	Beam	CCT	Surface	Finish
 REBD42 户外矮柱灯	06 6W	E ON-OFF	A ≥100°	27 2700K 30 3000K 40 4000K	N NA	BK Black BZ Bronze

示例: REBD42-06E-A27NBK

TOWER

Model	LED Power	Driver	Beam	CCT	Surface	Finish
 REBF42 户外矮柱灯	10 10W	E ON-OFF	A ≥100°	27 2700K 30 3000K 40 4000K	N NA	BK Black BZ Bronze





示例: REBF42-10E-A27NBK

LINEAR

Model	LED Power	Driver	Beam	CCT	Surface	Finish
 REBB42 户外矮柱灯	06 6W	E ON-OFF	A ≥100°	27 2700K	N NA	BK Black 
				30 3000K		BZ Bronze 
				40 4000K		

示例: REBB42-06E-A27NBK

MUSHROOM



Model	LED Power	Driver	Beam	CCT	Surface	Finish
 REBI31 户外矮柱灯	08 8W	E ON-OFF	A ≥100°	27 2700K	N NA	WT White 
				30 3000K		BK Black 
				40 4000K		BZ Bronze 

示例: REBI31-08E-A27NWT

Model	LED Power	Driver	Beam	CCT	Surface	Finish
 REBI41 户外矮柱灯	08 8W	E ON-OFF	A ≥100°	27 2700K	N NA	WT White 
				30 3000K		BK Black 
				40 4000K		BZ Bronze 

示例: REBI41-08E-A27NBK

SCOOP

Model	LED Power	Driver	Beam	CCT	Surface	Finish
 REBH41 户外矮柱灯	10 10W	E ON-OFF	A ≥100°	27 2700K	N NA	BK Black 
				30 3000K		BZ Bronze 
				40 4000K		

示例: REBH41-10E-A27NBK

MINI ACCENT 单头出光

Model	Power	Driver	Beam Angle	CCT	Surface	Finish
 U6111 Mini	1W-7W 旋钮可调	12V AC	10°/25°/40°/50° 四挡旋钮可调节	27 2700K	/	BBR Bronze on Brass 
				30 3000K		BZ Bronze on Aluminum 



示例: U6111-27BBR

MINI ACCENT 双头出光

Model	Power	Driver	Beam Angle	CCT	Surface	Finish
 U6211 旋钮可调 (单头)	1W-7W 旋钮可调 (单头)	12V AC	10°/25°/40°/50° 四挡旋钮可调节	27 2700K	/	BBR Bronze on Brass 
				30 3000K		BZ Bronze on Aluminum 



示例: U6211-27BBR

LEDGE

Model	Power	Driver	Beam Angle	CCT	Surface	Finish
 U6081 Ledge	3W	12V AC	≥100°	27 2700K	/	BK Black on Aluminum 
				30 3000K		BZ Bronze on Aluminum 



示例: U6081-27BK

SLIDE

Model	Power	Driver	Beam Angle	CCT	Surface	Finish
 U6321 Slide 24IN	3W	12V AC	≥100°	30 3000K	/	BZ Bronze on Aluminum 







示例: U6321-30BZ

SLIDE

Model	Power	Driver	Beam Angle	CCT	Surface	Finish
 U6311 Slide 15IN	3W	12V AC	≥100°	30 3000K	/	BZ Bronze on Aluminum 







示例: U6311-30BZ

BALANCE

Model	Power	Driver	Beam Angle	CCT	Surface	Finish
 U6061 Balance	6.5W	12V AC	≥100°	27 2700K 30 3000K	/	BK Black on Aluminum  BZ Bronze on Aluminum 
 U6071 Db Balance	10W	12V AC	≥100°	27 2700K 30 3000K	/	BK Black on Aluminum  BZ Bronze on Aluminum 





示例: U6061-27BK

TIKI

Model	Power	Driver	Beam Angle	CCT	Surface	Finish
 U6042 Tiki	6.5W	12V AC	≥100°	27 2700K 30 3000K	/	BK Black on Aluminum  BZ Bronze on Aluminum 
 U6041 Tiki	6.5W	12V AC	≥100°	27 2700K 30 3000K	/	BBR Bronze on Brass  BK Black on Aluminum  BZ Bronze on Aluminum 

示例: U6042-27BK

AREA

Model	Power	Driver	Beam Angle	CCT	Surface	Finish
 U6011 Area	5.8W	12V AC	≥100°	27 2700K 30 3000K	/	BBR Bronze on Brass  BZ Bronze on Aluminum  BK Black on Aluminum 

示例: U6011-27BK

DOWNLIGHT PART 筒灯配件
辰星配件

Fit Series	Fit Size	Part	Part Name
	RDA 辰星筒灯	PART 配件	GL-E 拉伸玻璃 (椭圆配光)
			HC 蜂窝

示例: RDAL21-PART-GL-E

Fit Series	Fit Size	Part	Part Name
	RDA 辰星筒灯	PART 配件	PL 防雾玻璃组件

示例: RDAL21-PART-PL

TRACK SYSTEM 轨道系统

高压轨道系统配件
CECIO配件

Fit Series	Fit Size	Part	Part Name	Type
RDA 辰星筒灯	L21 2"	PART 配件	DR 无边预埋件	6 方形无边
	L31 3"			2 圆形无边

示例: RDAL26-PART-TL

Fit Series	Fit Size	Part	Part Name
RDA 辰星筒灯	L22 2"	PART 配件	TO 开孔器
	L26 2"		
	L32 3"		
	L36 3"		

Fit Series	Fit Size	Part	Part Name
RDA 辰星筒灯	L21	PART 配件	RE-W
	D21		RE-W
	L21		RE-W
	L31		RE-W
	D31		RE-W
	M35		RE-W
	M35		2RE-W
			3RE-W
	L41		RE-W
	D41		RE-W
L45	RE-W		

示例: RDAL21-PART-RE-W

Fit Series	Fit Size	Part	Part Name
RDA 辰星筒灯	L21 2" L41 4"	PART 配件	DR-A DALI驱动

示例: RDAL21-PART-DR-A

Fit Series	Fit Size	Part	Part Name
RTB 高压三回路轨道系统	SS Small Spot	PART 配件	W2BK 明装三回路轨道 黑色 L2000mm W1BK 明装三回路轨道 黑色 L1000mm W2WT 明装三回路轨道 白色 L2000mm W1WT 明装三回路轨道 白色 L1000mm

示例: RTBSS-PART-W2BK

Fit Series	Fit Size	Part	Part Name
RTB 高压三回路轨道系统	SS Small Spot	PART 配件	ILBK 端部进电接头(地线左侧) 黑色 ILWT 端部进电接头(地线左侧) 白色

示例: RTBSS-PART-ILBK

Fit Series	Fit Size	Part	Part Name
RTB 高压三回路轨道系统	SS Small Spot	PART 配件	IRBK 端部进电接头(地线右侧) 黑色 IRWT 端部进电接头(地线右侧) 白色

示例: RTBSS-PART-IRBK

Fit Series	Fit Size	Part	Part Name
RTB 高压三回路轨道系统	SS Small Spot	PART 配件	AFBK 低压轨道黑色标准明装轨道尾盖 AFWT 低压轨道白色标准明装轨道尾盖



示例: RTBSS-PART-AFBK

低压轨道系统配件
低压嵌入式无边轨道及配件







Fit Series	Fit Size	Part	Part Name
	RTB 高压三回路轨道系统	SS <i>Small Spot</i>	PART 配件
			ICWT 轨道连接器, 白色 ICBK 轨道连接器, 黑色

示例: RTBSS-PART-ICWT

低压轨道系统配件
低压嵌入式轨道及配件

Fit Series	Fit Size	Part	Part Name
	RTM 低压轨道系列	SS <i>Small Spot</i>	PART 配件
			B1BK 低压轨道嵌入式黑色轨道 L1000mm B1WT 低压轨道嵌入式白色轨道 L1000mm B2BK 低压轨道嵌入式黑色轨道 L2000mm B2WT 低压轨道嵌入式白色轨道 L2000mm
	RTM 低压轨道系列	SS <i>Small Spot</i>	PART 配件
			BDWT 低压轨道嵌入式轨道扩口支架
	RTM 低压轨道系列	SS <i>Small Spot</i>	PART 配件
			BFBK 低压轨道嵌入式黑色轨道尾盖 BFWT 低压轨道嵌入式白色轨道尾盖

示例: RTMSS-PART-B2BK

Fit Series	Fit Size	Part	Part Name
	RTM 低压轨道系列	SS <i>Small Spot</i>	PART 配件
			C1BK 低压轨道嵌入式黑色无边轨道 L1000mm C1WT 低压轨道嵌入式白色无边轨道 L1000mm C2BK 低压轨道嵌入式黑色无边轨道 L2000mm C2WT 低压轨道嵌入式白色无边轨道 L2000mm
	RTM 低压轨道系列	SS <i>Small Spot</i>	PART 配件
			CDBK 低压轨道嵌入式轨道黑色连接片 CDWT 低压轨道嵌入式轨道白色连接片
	RTM 低压轨道系列	SS <i>Small Spot</i>	PART 配件
			CFBK 低压轨道嵌入式轨道黑色尾盖 CDWT 低压轨道嵌入式轨道白色尾盖
	RTM 低压轨道系列	SS <i>Small Spot</i>	PART 配件
			CLBK 低压轨道嵌入式黑色无边轨道L型金属转角 CLWT 低压轨道嵌入式白色无边轨道L型金属转角
	RTM 低压轨道系列	SS <i>Small Spot</i>	PART 配件
			CMWT 低压轨道嵌入式轨道安装拉手
	RTM 低压轨道系列	SS <i>Small Spot</i>	PART 配件
			CVBK 低压轨道嵌入式黑色无边轨道外部垂直金属转角 CVWT 低压轨道嵌入式白色无边轨道外部垂直金属转角

示例: RTMSS-PART-C1BK



RTM
低压轨道系列

SS Small Spot

PART 配件

CUWT 低压轨道嵌入式白色无边轨道内部垂直金属转角
CUBK 低压轨道嵌入式黑色无边轨道内部垂直金属转角

示例: RTMSS-PART-CUWT

Fit Series

Fit Size

Part

Part Name

低压轨道系统配件
低压L型连接接驳配件



RTM
低压轨道系列

SS Small Spot

PART 配件

LIBK 低压轨道黑色L型接驳器 内部键位
LIWT 低压轨道白色L型接驳器 内部键位
LOBK 低压轨道黑色L型接驳器 外部键位
LOWT 低压轨道白色L型接驳器 外部键位
LCBK 低压轨道黑色L型接驳器
LCWT 低压轨道白色L型接驳器

示例: RTMSS-PART-LIBK

Fit Series

Fit Size

Part

Part Name

低压轨道系统配件
低压轨道软连接接驳配件



RTM
低压轨道系列

SS Small Spot

PART 配件

ICBK 低压轨道黑色软连接接驳器
ICWT 低压轨道白色软连接接驳器

示例: RTMSS-PART-ICBK

Fit Series

Fit Size

Part

Part Name

低压轨道系统配件
低压轨道进电端配件



RTM
低压轨道系列

SS Small Spot

PART 配件

ILBK 低压轨道黑色短款进电端 左键位
ILWT 低压轨道白色短款进电端 左键位
IRBK 低压轨道黑色短款进电端 右键位
IRWT 低压轨道白色短款进电端 右键位
IEBK 低压轨道黑色短款进电端
IEWT 低压轨道白色短款进电端

示例: RTMSS-PART-CUWT

低压轨道系统配件
低压标准明装轨道及配件

Fit Series

Fit Size

Part

Part Name



RTM
低压轨道系列

SS Small Spot

PART 配件

A1BK 低压轨道黑色标准明装轨道 L1000mm
A1WT 低压轨道嵌入式白色标准明装轨道 L1000mm
A2BK 低压轨道黑色标准明装轨道 L2000mm
A2WT 低压轨道白色标准明装轨道 L2000mm



RTM
低压轨道系列

SS Small Spot

PART 配件

ADBK 低压轨道黑色标准明装轨道扩口支架
ADWT 低压轨道白色标准明装轨道扩口支架



RTM
低压轨道系列

SS Small Spot

PART 配件

AFBK 低压轨道黑色标准明装轨道尾盖
AFWT 低压轨道白色标准明装轨道尾盖

示例: RTMSS-PART-A1BK

LINEAR SYSTEM PART 线性系统配件
LED柔性灯带配件

Fit Series

Part

Part Name

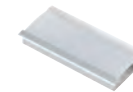

RSSL12

PART-01

平面固定灯带型材带塑料罩



RSSL12

PART-02

斜面 45°固定灯带型材带塑料罩



RSSL12

PART-04

嵌入式固定灯带型材带塑料罩

示例: RSSL12-PART-01

Fit Series	Part	Part Name
	RS5L12	PART-05 无边固定灯带型材带塑料罩

示例: RS5L12-PART-05

Part	Part Name
	CA03BK 双端Type-C连接线
	DR-E 24V恒压适配器 Tpye-C接口

示例: RLCLNS-PART-CA03BK

线性明装灯具配件



PENDENT LIGHT PART吊灯配件

Model	part name
	RPECSA-PART-DR-T 24V恒压电源

















示例: RPECSA-PART-DR-T

LANDSCAPE PART户外景观灯配件

景观灯配件

Model	part name	Finish
	U9000 ST9 8寸注塑地插	BZ 咖啡色 

U9000-ST9-BZ

Model	part name	Finish
	U9000 SP9 不锈钢景观灯安装地插	
	U5000 SCP 景观灯地面安装盖	BK 黑色  BZ 咖啡色  BBR Bronze on Brass 
	U5000 TCP 景观灯树上安装盒	BZ 咖啡色  Bk 黑色 
	U5000 GM 3寸不锈钢水槽安装支架	BZ 咖啡色  BK 黑色 
	U5000 LCO 1/2管螺纹L型钢接头	BK 黑色  BZ 咖啡色 
	U5000 X 1/2管螺纹连接铜管	BK 黑色  BZ 咖啡色  BBR Bronze on Brass 

U900-SP9

埋地灯配件

Model	part name	Finish
	U5030 GRD 景观埋地灯防护罩	BZ 咖啡色  BBR Bronze on Brass 

U5030-GRD-BZ

Model	part name	Finish
	U5030 PIP 景观埋地灯塑胶预埋组件	PT PT色 

示例: U5030-PIP-PT

光学配件

Model	part name
	ULENS 11-GRN 绿色玻璃配件 11-RED 红色玻璃配件 11-BLU 蓝色玻璃配件 11-FR 清玻璃配件

	ULENS 16-GRN 绿色玻璃配件Φ50x3 (平板) 16-RED 红色玻璃配件Φ50x3 (平板) 16-BLU 蓝色玻璃配件Φ50x3 (平板) 16-FR 清玻璃配件Φ50x3 (平板)
--	--

示例: ULENS-11-GRN

Model	part name
	ULENS 25-AMB 18W琥珀色玻璃配件 25-GRN 18W绿色玻璃配件 25-RED 18W红色玻璃配件 25-BLU 18W蓝色玻璃配件 25-FR 18W单面喷砂玻璃配件 25-HCL 18W蜂窝网

示例: ULENS-25-AMB

Model	part name
	ULENS 2X4-FR 喷砂钢化玻璃40*33*3mm(平板)









Model	part name
	ULENS 2X3-FR 喷砂玻璃配件 2X3

示例: ULENS-2X4-FR

Model	part name
	ULENS 25-HCL 18W 蜂窝网

	U5121 HCL 迷你景观洗墙灯系列蜂窝配件
---	--

示例: ULENS-25-HCL

Model	part name	Finish
	U5111 LSHR-BBR 铜质5寸出光罩	BZ 咖啡色 
	LSHR-BK 铜质5寸出光罩	BK 黑色 
	LSHR-BZ 铜质5寸出光罩	BZ 咖啡色 
	U5211 SNOOT-BBR 铜质平口出光罩配件	BZ 咖啡色 
	SNOOT-BK 铜质平口出光罩配件	BK 黑色 
	SNOOT-BZ 铜质平口出光罩配件	BZ 咖啡色 

U5111-LSHR-BBR

UT24-OD1配件

Model	part name
	UPS 24DC-U96R-WE 24V恒压电源 AC120V-277V输入

UPS-24DC-U96R-WE

	UT24-WE IC-002-BK Joiner灯带连接线 5cm
	IC-006-BK Joiner灯带连接线 15cm
	IC-012-BK Joiner灯带连接线 30cm
	IC-036-BK Joiner灯带连接线 90cm
	IC-072-BK Joiner灯带连接线 180cm
	IC-144-BK Joiner灯带连接线 360cm
IC-240-BK Joiner灯带连接线 600cm	

UPS-24DC-U96R-WE

	Model	part name
	UT24-WE	B072-BK InvisiLED 接线线(室内电源) 10cm 24v B012-BK InvisiLED 接线线(室内电源) 30cm 24v
	UT24-WE	EX2-006-BK InvisiLED 电源连接线 15cm 24V
	UT24-WE	Y-BK Invisiled灯带 Y型 3位连接件
	UT24-WE	EC 灯带防水端盖
	ULED-TO24	C1 灯带双侧明装固定卡扣
	ULED-TO24	C2 灯带双侧明装固定卡扣
	UT24-WE	C3 灯带 InvisiLED 背装固定卡扣

示例: UT24-WE-B072-BK





	Model	part name
	UT24-WE	CH5 灯带型材 1.5m
	UT24-WE	SI-45 防水硅胶

示例: UT24-WE-CH5

ULED-TO24配件



	Model	part name
	UEN-O24100	RB2-T 24V恒压电源 AC120V-277V输入
	ULED-TO24	CH5 灯带型材 1.5m
	ULED-TO24	C1 灯带双侧明装固定卡扣
	ULED-TO24	C2 灯带单侧明装固定卡扣
	ULED-TO24	C3 背装固定卡扣

示例: UEN-O24100-RB2-1

Model	part name
 ULED-TO24	IC6 Joiner灯带连接线 15cm IC12 Joiner灯带连接线 30cm IC72-RGB Joiner灯带连接线 RGB 180cm IC120 Joiner灯带连接线 300cm
 ULED-TO24	Y Y型 4位连接件
 ULED-TO24	X X型 4位连接件
 ULED-TO24	EC 灯带防水端盖

示例: ULED-TO24-IC6

ULED-TCO配件

Model	part name
 UEN-O24100	RB2-T 24V恒压电源 AC120V-277V输入
 ULED-TO24	CM RGB 24V恒压输入 主控器
 ULED-TO24	CS RGB 24V恒压输入 分控器

示例: UEN-O24100-RB2-T

Model	part name
 ULED-TO24	WS RGB 遥控器 (控制器)
 ULED-TO24	CH5 灯带型材 1.5m
 ULED-TO24	C1 灯带双侧明装固定卡扣
 ULED-TO24	C2 灯带单侧明装固定卡扣
 ULED-TO24	C3 背装固定卡扣

Model	part name
 ULED-TO24	IC6 Joiner灯带连接线 15cm IC12 Joiner灯带连接线 30cm IC72 Joiner灯带连接线 180cm IC120 Joiner灯带连接线 300cm
 LED-TO24	SW60 RGB 信号线 (控制器) 150cm SW120 RGB 信号线 (控制器) 300cm
 LED-TO24	MW60 InvisiLED RGB DMX信号线 150cm MW120 InvisiLED RGB DMX信号线 300cm

示例: ULED-TO24-WS

	Model	part name
	ULED-TO24	IC6-RGB Joiner灯带连接线 RGB 15cm IC12-RGB Joiner灯带连接线 RGB 30cm IC72-RGB Joiner灯带连接线 RGB 180cm
	ULED-TO24	Y-RGB RGB Y型 4位连接件
	ULED-TO24	X-RGB RGB X型 4位连接件
	ULED-TO24	EC invisILED 灯带防水端盖



示例: ULED-TO24-IC6-RGB

U8配件

	Model	part name
	ULED-TO24	CH5 灯带型材 1.5m
	ULED-TO24	C1 灯带双侧明装固定卡扣

示例: ULED-TO24-CH5

	ULED-TO24	C2 灯带单侧明装固定卡扣
	ULED-TO24	C3 背装固定卡扣
	ULED-TO24	EC 灯带防水端盖
	U8000	06BK 灯带连接线带5安倍保险 180CM 10BK 灯带连接线带5安倍保险 300CM
	U8001	6BK Joiner灯带连接线 15cm 12BK Joiner灯带连接线 30cm 72BK Joiner灯带连接线 180cm 120BK Joiner灯带连接线 300cm

	Model	part name	Finish
	U8002	Y型 3位连接件	BK Black 
	U8003	X型 4位连接件	BK Black 

示例: U8003-BK